

ORECK[®] XL_{|||||}[®]

S I M P L Y A M A Z I N G[®]

Service Parts List

Upright Vacuum Cleaner Models



- | | |
|------------|-----------------------|
| XL2600HH | U2310RD |
| XL2610HH | XL2450RH |
| XL2700HH | XL2000HH |
| XL2700RHY | XL2100HH |
| XL2800H2W | U2000HH |
| XL2800H2B | XL2000RH |
| XL2800H2US | XL2100RH |
| XL2800HAY | XL2090RHM |
| XL2540RH | XL2070RH |
| XL2320RH | XL2000RS |
| U2640RH | XL2100RS |
| U2510RH | XL2090RSM |
| U2520RH | U2420RSQ |
| U2530RH | U2540RH |
| XL2400RS | |
| XL2330HS | <u>CLASSIC SERIES</u> |
| XL2330RS | U2250RS |
| U2330RD | |
| U2740RD | |
| XL2250RS | |
| XL2260RS | |
| XL2500RH | |
| XL2500HH | |
| XL2200RS | |
| U2200RD | |
| XL2300RS | |
| XL2310RS | |
| U2310RSF | |

REV BY. Please disregard all earlier versions.

Type 1, 2, 3, 4, 5, 6 & 7

Product Information

- Minimum water lift: 9 in. @ nozzle sealed suction
- Power consumption 120V/60Hz: 4.0 amps, 480 watts
- Weight: 8 lbs. without power cord
- Switch rating: 8 amps, 120 volts
- Power cord rating - Domestic 18/2 SJT 105°C
Commercial: 18/3 SJT 105°C

Service Information

- Component configuration on exploded view may differ in case of specific versions. However, the actual components are distinguished by means of item and part numbers.
- If a repair has been made, make sure that all functions of the appliance are working correctly.
- Spare parts have been standardized as much as possible and the part may not be the exact replacement part.
- Only the new **METAXALLOY™** motor fan available.
- Only the new soft single rear wheel style available.
- Only housings with belt access door available.
- When assembling fan seal to fan housing, use a small bead of silicone.
- Only new plastic detent available.
- Baseplate assemblies with one-piece wireform are interchangeable on Type 1-6 units.

Data Label



Type Code: Represents product service revision number.

Type 1: Initial Production

Type 2: Improved strain relief D-Grip Handle.

Type 3: Improved deflector and removed collar set screw.

Type 4: Square cord retainer.

Type 5: Improved lower tube.

Type 6: Hardwire handle.

Type 7: Improved baseplate with one-piece wireform.

Julian Date Code:

Represents date of manufacture.

98 Represents the year.

166 Represents the day in that year

STANDARD FASTENER HARDWARE LISTING

Fasteners Fit Uprights Listed in Service Manual

#	FASTENER DESCRIPTION	FASTENER PART NO.	PART THAT FASTENER IS USED ON	QTY REQ'D	TORQUE RANGE (in/lb)	QTY PER PKG.	
2	Cord Clamp	03-00613-01M	Foot Switch Units	1	n/a	100	
		03-00619-01M	D-Handle Units	1	n/a	100	
3	Screw, #8 - 32 x .440 Nylock Screw, #8 x .811 w/ Int Washer	03-00478-02M	Handle Tube	2	18 - 22	100	
		03-00608-01M	Handle Tube w/Through Bolt	1	18 - 22	100	
	Screw, #8-32 X .545 w/ Washer Screw, #8 - 32 x 29/32 w/ Washer	03-00504-02M	Handle Brace	2	18 - 22	100	
		03-00605-01M	Handle Brace w/Through Bolt	1	18 - 22	100	
15	Screw, #8 X .5 Phillips	03752-01M	Headlight Cover, Bulb Holder, Foot Switch, Cable Clamp	2/2 2/1	13 - 16	100	
30	1/4 X 32 Yellow Chrome	03-00448-01M	Fan	1	18 - 20	100	
38	Screw, #8 X .75 Phillips Screw, #8 x .75	03-00456-01M	D-Handle (small head)	4	17 - 20	100	
		03-00476-01M	D-Handle Type 6 & 7 Only	6	17 - 20	100	
41	Wire Nut	03-00599-01M		as req'd	35 - 55	100	
48	Screw, #8 x .75 Phillips	03-00476-01M	Baseplate, Belt Door,	5 / 1	13 - 16	100	
			Intake Pivot,	1	13 - 16	100	
			Motor	2	17 - 20	100	
49	Screw, #7 X .38 Phillips	03-00475-01M	Edge Brush Type 1-6 Only , Detent	2 / 2	5 - 8	100	
63	Screw, #10 x .5 Phillips	03-00450-01M	Cord Bracket	1	13 - 16	100	
68	Screw, #6-20 x 1/4"	03-00482-01M	Collar Type 1 & 2 Only	2	4 - 5	100	
69	O-Ring	75191-02M	Collar	2	n/a	100	
72	Washer, Thrust	03-00479-01M	Fan	1	n/a	100	
73	Washer, Lock External Tooth	03-00480-01M	Fan	1	n/a	100	
74	1" x 3", Loop Fastener	75304-01M	Bag Support	1	n/a	100	
75	1" x 1", Hook Fastener	75303-01M	Bag Dock	2	n/a	100	
77	Retainer Clip	03528M	Baseplate Type 1-6 Serviceable	2	n/a	100	
78	Wireform	75194-03M	Baseplate Type 1-6 Serviceable	2	n/a	100	
82	Steel Bushing Ring	03-00598-01M	D-Handle	1	n/a	100	
84	Nut, Square	03-00606-01M	Connector	1	n/a	100	
85	Screw, #6-20 x 7/16 Flat Undercut	03-00626-01M	Edge Brush, Channel Type 7 Only	2 / 3	6 - 8	100	
86	Wireform, One-Piece	75698-01	Baseplate Type 7 Only	1	n/a	1	
88	JST Insulator	75679-01M	Harness	1	n/a	100	
89	Rivet	03-00453-01M	Fan Housing	1	n/a	100	
90	Bag Spring	75015-01M	Fan Housing	1	n/a	100	
91	Push Nut	03-00636-01M	Fan Housing	1	n/a	100	

Parts Diagram

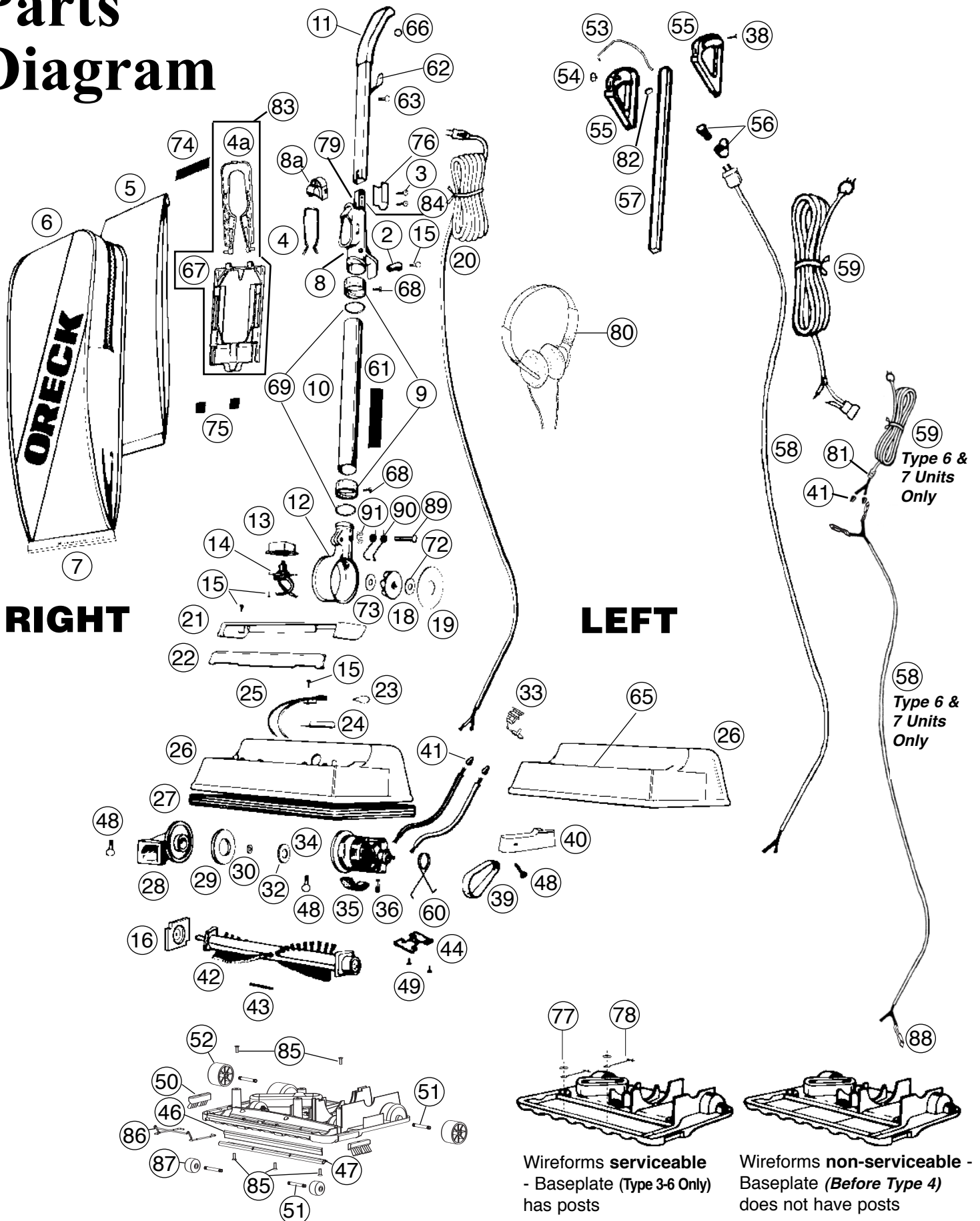

Classic Parts Diagram

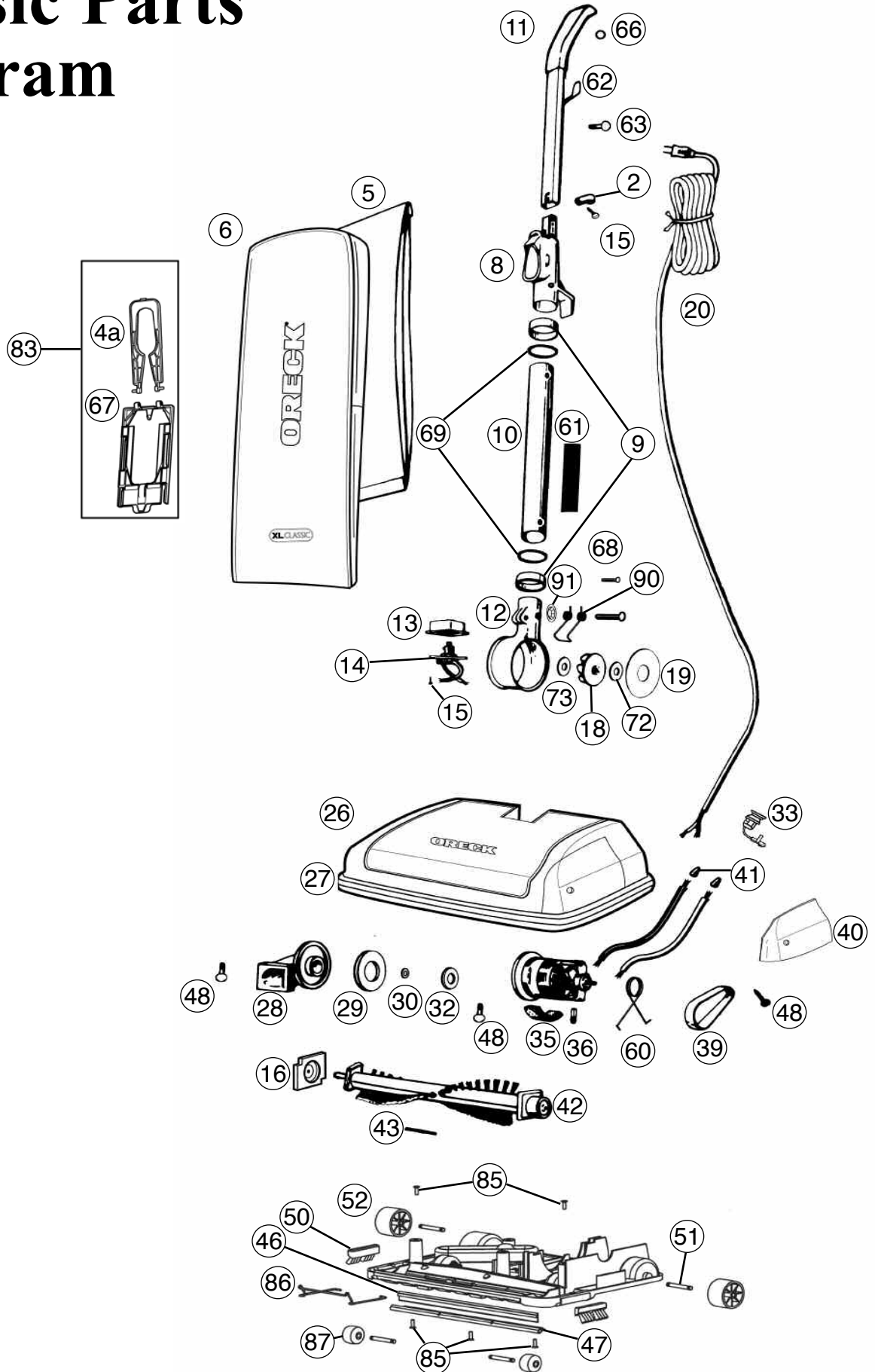

Parts Assemblies

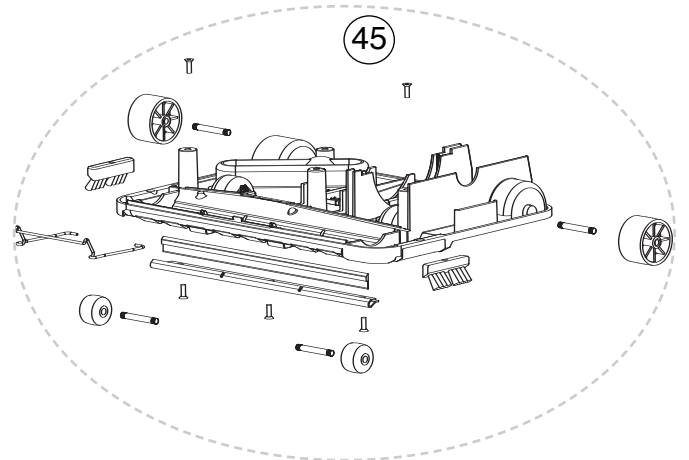
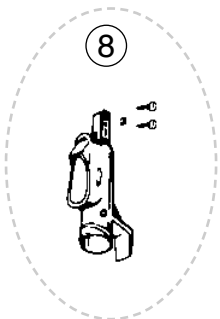
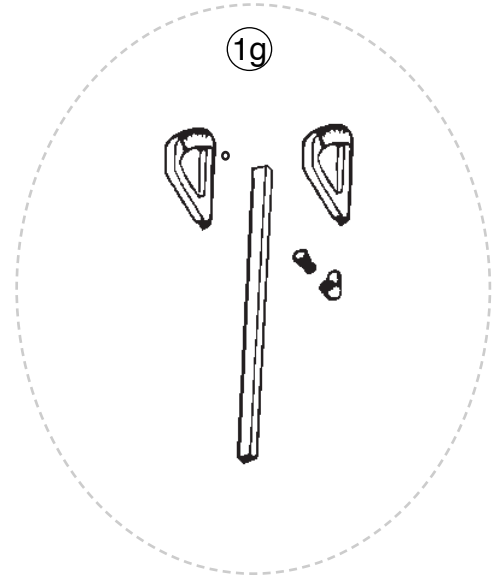
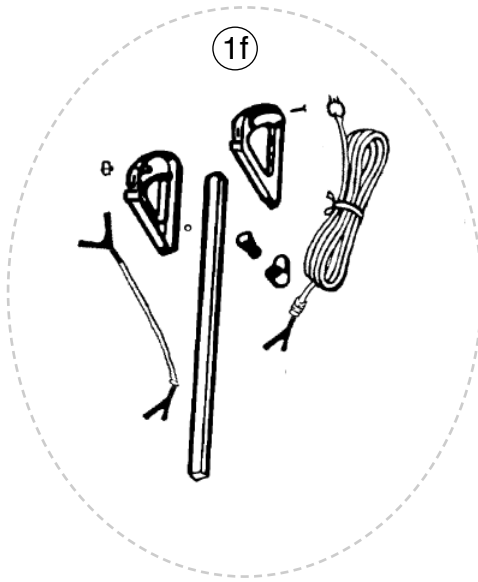
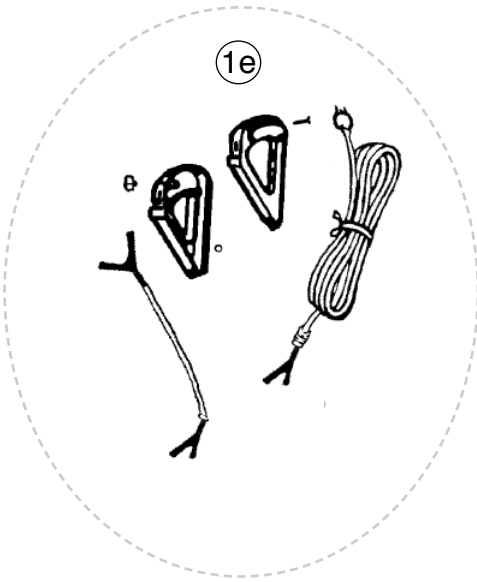
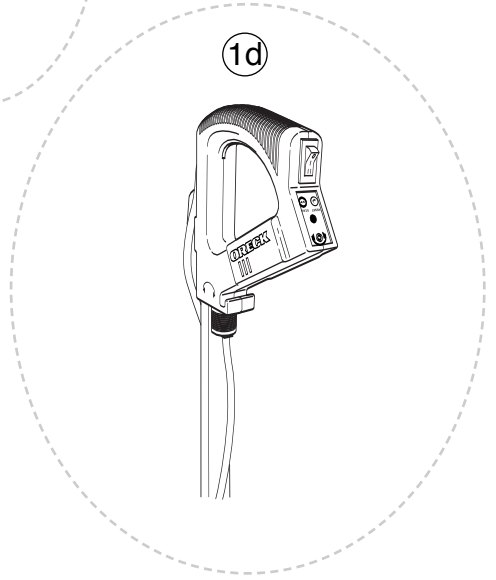
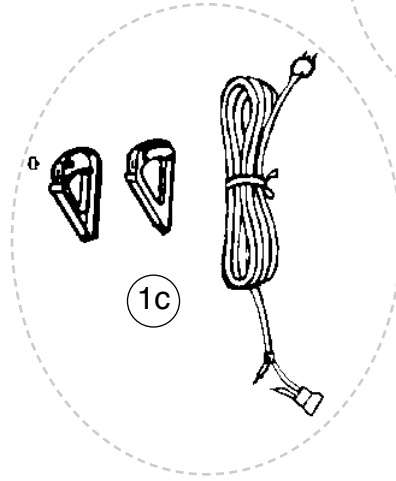
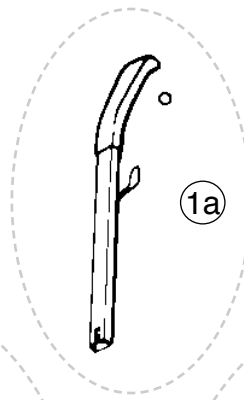

Part Numbers Listing: XL2600HH, XL2610HH, XL2700HH & XL2700RH Hypo Bag, Lights, Helping Hand Handle

#	Item	Order #	Qty.	Pk.			
1b	XL2600HH / XL2610HH: Handle Assembly, <i>includes items #38, #53, #54, #55, #56, #57, #59 Type 1, 2, 3, 4 & 5 Units Only</i>	09-75288-01 ORDER 1e	1	1	NLA	NLA	NLA
	XL2700HH / XL2700RH: Handle Assembly, <i>includes items #38, #53, #54, #55, #56, #57, #59 Type 1, 2, 3, 4 & 5 Units Only</i>	09-75288-04 ORDER 1e	1	1	NLA	NLA	NLA
1c	XL2600HH / XL2610HH: Tortuous Grip & Cord Assembly, <i>includes items #54, #55, #59 Type 1 Units Only</i>	09-75342-04 ORDER 1e	1	1	NLA	NLA	NLA
	XL2700HH / XL2700RH: Tortuous Grip & Cord Assembly, <i>includes items #54, #55, #59 Type 1 Units Only</i>	09-75342-04 ORDER 1e	1	1	NLA	NLA	NLA
1e	Kit, Retro, Handle Assembly, Residential, White, <i>includes items #38, #54, #55, #58, #59, #81 #82 Type 1, 2, 3, 4 & 5 Units Only</i>	09-75612-01	1	1			
4a	Docking Clip, Rear, Type CC (use w/#67 or order #83)	75583-03-0000	1	1			
5	Dust Bag, (8 Pk.) Hypo Allergenic	CCPK8DW	1	8			
	Dust Bag, (25 Pk.) Hypo Allergenic	CCPK25DW	1	25			
6	XL2600HH / XL2610HH / XL2700HH: Outer Bag, Lt. Gray, Black, Dark Gray	75246-10	1	1			
	XL2700RH: Outer Bag, Dark Gray, Black, Dark Gray	75246-11	1	1			
7	XL2600HH: Bag Clip, Gray	09-75078-07	1	1			
	XL2610HH: Bag Clip, Gray w/ Gold	09-75078-14	1	1			
	XL2700HH / XL2700RH: Bag Clip, Black	09-75078-06	1	1			
8	Connector Assembly Kit, <i>includes items #3 & #84</i>	09-75308-57	1	1			
8a	Deflector, Black, Snap Type 1 & 2 Units Only	75220-01-0327	1	1			
9	Collar	75309-02-0327	2	1			
10	Tube Assembly Type 1, 2, 3 & 4 Units Only	75188-01	1	1			
	Tube Assembly Type 5 & 6 Units Only	75198-05	1	1			
12	Fan Housing Assembly <i>includes Rivet & Spring</i>	09-75343-03	1	1			
16	End Cap	0134623	1	1			
18	METAXALLOY™ Fan Kit w/Washers	09-75300-01	1	1			
19	Fan Cup Seal	75012-01	1	1			
20	Cord Set	<i>see #59</i>					
21	XL2600HH: Lamp Housing w/Reflectors, Gray	09-75073-08	1	1			
	XL2610HH: Lamp Housing w/Reflectors, Gray w/Gold	09-75073-12	1	1			
	XL2700HH / XL2700RH: Lamp Housing w/Reflectors, Black	09-75073-07	1	1			
22	Lens	75058-01-0329	1	1			
23	Bulb	00965-0019	2	1			
24	Bulb Reflector	75034-01	4	1			
25	Lamp Holder	75539-01	1	1			
26	XL2600HH / XL2610HH: Housing w/Reflectors, Gray	09-75429-03	1	1			
	XL2700HH / XL2700RH: Housing w/Reflectors, Black	09-75429-01	1	1			
27	Bumper, White	75181-03	1	1			
28	Intake Pivot Assembly, <i>with Felt Seal</i>	09-75066-02	1	1			
29	Felt Seal	75065-01	1	1			
32	Felt Seal, Motor	75117-01M	1	100			
33	XL2600HH / XL2610HH: Cord Retainer, Round Type 1, 2 & 3 Units Only	03-00455-01	1	1			
	XL2700HH / XL2700RH: Cord Retainer, Round Type 1, 2 & 3 Units Only	03-00455-02	1	1			
	Cord Retainer, Square Type 4, 5 & 6 Units Only	03-00494-01	1	1			
34	Motor Assembly Kit	09-75505-01	1	1			
35	Motor Seal	75095-01	2	1			
36	Kit, Motor Brush (Large & Small) / Spring	09-75514-01	2	2			

Part Numbers Listing: XL2600HH, XL2610HH, XL2700HH & XL2700RH cont.

Hypo Bag, Lights, Helping Hand Handle

#	Item	Order #	Qty.	Pk.			
39	Drive Belt, (3 Pk.)	0300604	1	3			
39a	Drive Belt, Single	75024-01	1	1			
40	XL2600HH / XL2610HH: Door Belt, Gray	75057-01-436	1	1			
	XL2700HH / XL2700RH: Door Belt, Black	75057-01-0327	1	1			
42	Brush Roll, Plastic Pulley	75202-01	1	1			
43	Seal, Baseplate	75008-01	1	1			
44	Plastic Detent, (uses 2 #49 screws)	75299-01	1	1			
45	Complete Baseplate Assembly <i>includes: #43, #46, #47, #50, #51, #52, #85, #86, #87</i>	09-75715-01	1	1			
46	MICRO SWEEP Blade	75009-01	1	1			
47	Channel	75007-02	1	1			
50	Edge Brush w/Wheels, Left	09-75249-02	1	1			
	Edge Brush w/Wheels, Right	09-75250-02	1	1			
51	Wheel Axle	03-00630-01M	2	100			
52	Soft Rear Wheel, Black	75187-02-0327	2	1			
53	Static Wire Type 1, 2, 3, 4 & 5 Units Only	75037-01	1	1			
54	Switch, 2 Position Assembly Type 1, 2, 3, 4 & 5 Units Only	75110-02	1	1			
	Switch, 2 Position Assembly Type 6 Units Only	75559-01	1	1			
55	XL2600HH / XL2610HH: Grips, Gray Set Type 2, 3, 4 & 5 Units Only (Type 1 Units Order Assembly 1e For Grips)	09-75301-09	1	1			
	XL2600HH/XL2610HH: Grips, Gray Set Type 6 Units Only	09-75576-09	1	1			
	XL2700HH: Grips, Black Set Type 2, 3, 4 & 5 Units Only (Type 1 Units Order Assembly 1e For Grips)	09-75301-02	1	1			
56	XL2600HH / XL2610HH: Cord Wrap Assy, <i>includes Post & Cord Wrap</i>	09-75185-06	1	1			
	XL2700HH / XL2700RH: Cord Wrap Assy, <i>includes Post & Cord Wrap</i>	09-75185-01	1	1			
57	XL2600HH / XL2610HH: Handle Tube, Chrome	75190-03	1	1			
	XL2700HH / XL2700RH: Handle Tube, Black	75190-04	1	1			
58	XL2600HH / XL2610HH: Cord, Harness Assembly, White Type 1, 2, 3, 4 & 5 Units Only	75081-01	1	1			
	XL2600HH / XL2610HH: Cord, Harness Assembly, White Type 6 Units Only	75552-02-328	1	1			
	XL2700HH / XL2700RH: Cord, Harness Assembly, Black Type 1, 2, 3, 4 & 5 Units Only	75081-02	1	1			
59	XL2600HH / XL2610HH: Cord Set, White Type 2, 3, 4 & 5 Units Only (Type 1 Units Order Assembly 1e For Cord Set)	75292-01-328	1	1			
	XL2600HH / XL2610HH: Cord Set, White w/ #81 Type 6 Units Only	75556-02-328	1	1			
	XL2700HH / XL2700RH: Cord Set, Black Type 2, 3, 4 & 5 Units Only (Type 1 Units Order Assembly 1e For Cord Set)	75292-01-327	1	1			
60	Motor Spring	75283-01	2	1			
61	Tube Label	75087-05	1	1			
67	Bag Dock Hinge, Type CC (use w/#4a or order #83)	75582-03-0000	1	1			
	User's Manual	75416-05	1	1			
	Magnet Clean Vacuum Protector	MC4BK	1	1			
79	Stiffener (uses same length screws, notched)	75189-02	1	1			
	Stiffener, Through Bolt Connector (uses different length screws)	75619-01	1	1			
81	Cord Flex Relief Type 6 Units Only	03-00600-01	1	1			
83	Kit, Bag Dock, <i>includes items #4a & #67</i>	09-75657-01	1	1			

Part Numbers Listing: XL2700RHYcont.

Hypo Bag, Lights, Helping Hand Handle

#	Item	Order #	Qty.	Pk.			
1b	Handle Assembly, <i>includes items #38, #53,#54, #55, #56, #57, #59</i>	09-75288-13 ORDER 1e	1	1	NLA	NLA	NLA
1e	Kit, Retro, Handle Assembly, Residential, White, <i>includes items #38, #54, #55, #58, #59, #81 #82 Type 1, 2, & 3 Units Only</i>	09-75612-01	1	1			
4a	Docking Clip, Rear, Type CC (use with #67 or order #83)	75583-03-0000	1	1			
5	Dust Bag, (8 Pk.) Hypo Allergenic	CCPK8DW	1	8			
	Dust Bag, (25 Pk.) Hypo Allergenic	CCPK25DW	1	25			
6	Outer Bag, Lt. Gray, Black, Dark Gray	75246-11	1	1			
7	Bag Clip, Gray	09-75078-12	1	1			
8	Connector Assembly Kit, <i>includes items #3 & #84</i>	09-75308-57	1	1			
9	Collar	75309-02-0327	2	1			
10	Tube Assembly Type 1, 2, & 3 Units Only	75188-01	1	1			
12	Fan Housing Assembly <i>includes Rivet & Spring</i>	09-75343-03	1	1			
16	End Cap	0134623	1	1			
18	METAXALLOY™ Fan Kit w/Washers	09-75300-01	1	1			
19	Fan Cup Seal	75012-01	1	1			
20	Cord Set	<i>see #59</i>					
21	Lamp Housing w/Reflectors, Yellow	09-75073-10	1	1			
22	Lens	75058-01-0329	1	1			
23	Bulb	00965-0019	2	1			
24	Bulb Reflector	75034-01	4	1			
25	Lamp Holder	75539-01	1	1			
26	Housing w/Reflectors, Yellow	09-75270-06	1	1			
27	Bumper, White	75181-03	1	1			
28	Intake Pivot Assembly, <i>with Felt Seal</i>	09-75066-02	1	1			
29	Felt Seal	75065-01	1	1			
32	Felt Seal, Motor	75117-01M	1	100			
33	Cord Retainer, Round	03-00455-01	1	1			
34	Motor Assembly Kit	09-75505-01	1	1			
35	Motor Seal	75095-01	2	1			
36	Kit, Motor Brush (Large & Small) / Spring	09-75514-01	2	2			
39	Drive Belt, (3 Pk.)	0300604	1	3			
39a	Drive Belt, Single	75024-01	1	1			
40	Door Belt, Yellow	75057-01-449	1	1			
42	Brush Roll, Plastic Pulley	75202-01	1	1			
43	Seal, Baseplate	75008-01	1	1			
44	Plastic Detent, (uses 2 #49 screws)	75299-01	1	1			
45	Complete Baseplate Assembly <i>includes: #43, #46, #47, #50, #51, #52, #85, #86, #87</i>	09-75715-01	1	1			
46	MICRO SWEEP Blade	75009-01	1	1			

Part Numbers Listing: XL2800H2W, XL2800H2B & XL2800H2US

Hypo Bag, Lights, Helping Hand Handle, 2-Speed

#	Item	Order #	Qty.	Pk.			
1b	XL2800H2W: Handle Assembly, Includes items #38, #53, #54, #55, #56, #57, #59	09-75288-03 ORDER 1e	1	1	NLA	NLA	NLA
	XL2800H2B: Handle Assembly, Includes items #38, #53, #54, #55, #56, #57, #59	09-75288-02 ORDER 1e	1	1	NLA	NLA	NLA
	XL2800H2US: Handle Assembly, Includes items #38, #53, #54, #55, #56, #57, #59	09-75288-15 ORDER 1e	1	1	NLA	NLA	NLA
1c	XL2800H2W: Tortuous Grip & Cord Assembly, includes items #54, #55, #59	09-75342-03 ORDER 1e	1	1	NLA	NLA	NLA
	XL2800H2B: Tortuous Grip & Cord Assembly, includes items #54, #55, #59	09-75342-02 ORDER 1e	1	1	NLA	NLA	NLA
1e	Kit, Retro, Handle Assembly, Residential, White, includes items #38, #54, #55, #58, #59, #81, #82 Type 1, 2, 3, 4 & 5 Units Only	09-75612-01	1	1			
4a	Docking Clip, Rear, Type CC (use w/#67 or order #83)	75583-03-0000	1	1			
5	Dust Bag, (8 Pk.) Hypo Allergenic	CCPK8DW	1	8			
	Dust Bag, (25 Pk.) Hypo Allergenic	CCPK25DW	1	25			
6	XL2800H2W / XL2800H2B: Outer Bag, Lt. Gray, Blk, Drk Gray	75246-10	1	1			
	XL2800H2US Outer Bag, Lt. Gray, Red, Red	75246-15	1	1			
7	XL2800H2W: Bag Clip, White	09-75078-05	1	1			
	XL2800H2B: Bag Clip, Black	09-75078-06	1	1			
	XL2800H2US: Bag Clip, Navy	09-75078-15	1	1			
8	Connector Assembly Kit, includes items #3 & #84	09-75308-57	1	1			
8a	Deflector, Black, Snap Type 1 & 2 Units Only	75220-01-0327	1	1			
9	Collar	75309-02-0327	2	1			
10	Tube Assembly Type 2, 3, & 4 Units Only	75188-01	1	1			
	Tube Assembly Type 5 Units Only	75198-05	1	1			
12	Fan Housing Assembly includes Rivet & Spring	09-75343-03	1	1			
16	End Cap	0134623	1	1			
18	METAXALLOY™ Fan Kit w/Washers	09-75300-01	1	1			
19	Fan Cup Seal	75012-01	1	1			
20	Cord Set	see #59					
21	XL2800H2W: Lamp Housing w/Reflectors, White	09-75073-05	1	1			
	XL2800H2B / XL2800H2US: Lamp Housing w/Reflectors, Black	09-75073-04	1	1			
22	Lens	75058-01-0329	1	1			
23	Bulb	00965-0019	2	1			
24	Bulb Reflector	75034-01	4	1			
25	Lamp Holder	75539-01	1	1			
26	XL2800H2W : Housing w/Reflectors, White	09-75429-02	1	1			
	XL2800H2B: Housing w/Reflectors, Black	09-75429-01	1	1			
	XL2800H2US : Housing, Navy	09-75780-39	1	1			
27	Bumper, White	75181-03	1	1			
28	Intake Pivot Assembly with Felt Seal	09-75066-02	1	1			
29	Felt Seal	75065-01	1	1			
32	Felt Seal, Motor	75117-01M	1	100			
33	XL2800H2W: Cord Retainer, Round Type 1, 2 & 3 Units Only	03-00455-01	1	1			
	XL2800H2B: Cord Retainer, Round Type 1, 2 & 3 Units Only	03-00455-02	1	1			
	Cord Retainer, Square Type 4 & 5 Units Only	03-00494-01	1	1			
34	Motor Assembly Kit	09-75505-01	1	1			

Part Numbers Listing: XL2800H2W, XL2800H2B & XL2800H2US cont.

Hypo Bag, Lights, Helping Hand Handle, 2-Speed

#	Item	Order #	Qty.	Pk.			
35	Motor Seal	75095-01	2	1			
36	Kit, Motor Brush (Large & Small) / Spring	09-75514-01	2	2			
39	Drive Belt, (3 Pk.)	0300604	1	3			
39a	Drive Belt, Single	75024-01	1	1			
40	XL2800H2W: Door Belt, White	75057-01-0431	1	1			
	XL2800H2B: Door Belt, Black	75057-01-0327	1	1			
	XL2800H2US: Door Belt, Navy	75057-01-0432	1	1			
42	Brush Roll, Plastic Pulley	75202-01	1	1			
43	Seal, Baseplate	75008-01	1	1			
44	Plastic Detent, (uses 2 #49 screws)	75299-01	1	1			
45	Complete Baseplate Assembly <i>includes: #43, #46, #47, #50, #51, #52, #85, #86, #87</i>	09-75715-01	1	1			
46	MICRO SWEEP Blade	75009-01	1	1			
47	Channel	75007-02	1	1			
50	Edge Brush w/Wheels, Left	09-75249-02	1	1			
	Edge Brush w/Wheels, Right	09-75250-02	1	1			
51	Wheel Axle	03-00630-01M	2	100			
52	Soft Rear Wheel, Black	75187-02-0327	2	1			
53	Static Wire Type 1, 2, 3, 4 & 5 Units Only	75037-01	1	1			
54	Switch, 3 Position Assembly w/Diode	75320-01	1	1			
55	XL2800H2W: Grips, White Set Type 2, 3, 4 & 5 Units Only (Type 1 Units Order Assembly 1e For Grips)	09-75301-19	1	1			
	XL2800H2B: Grips, Black Set Type 2, 3, 4 & 5 Units Only (Type 1 Units Order Assembly 1e For Grips)	09-75301-02	1	1			
	XL2800H2US: Grips, Red Set	09-75301-08	1	1			
56	XL2800H2W: Cord Wrap Assy, <i>includes Post & Cord Wrap</i>	09-75185-05	1	1			
	XL2800H2B: Cord Wrap Assy, <i>includes Post & Cord Wrap</i>	09-75185-01	1	1			
	XL2800H2US: Cord Wrap Assy, <i>includes Post & Cord Wrap</i>	09-75185-07	1	1			
57	XL2800H2W / XL2800H2US: Handle Tube, Chrome	75190-03	1	1			
	XL2800H2B: Handle Tube, Black	75190-04	1	1			
58	XL2800H2W / XL2800H2US: Cord, Harness Assembly	75081-01	1	1			
	XL2800H2B: Cord, Harness Assembly	75081-02	1	1			
59	XL2800H2W / XL2800H2US: Cord Set, White Type 2, 3, 4 & 5 Units Only (Type 1 Units Order Assembly 1e For Cord Set)	75292-01-328	1	1			
	XL2800H2B: Cord Set, Black Type 2, 3, 4 & 5 Units Only (Type 1 Units Order Assembly 1e For Cord Set)	75292-01-327	1	1			
60	Motor Spring	75283-01	2	1			
61	Tube Label	75087-05	1	1			
67	Bag Dock Hinge, Type CC (use w/#4a or order #83)	75582-03-0000	1	1			
	User's Manual	75416-05	1	1			
	Magnet Clean Vacuum Protector	MC4BK	1	1			
79	Stiffener (uses same length screws, notched)	75189-02	1	1			
	Stiffener, Through Bolt Connector (uses different length screws)	75619-01	1	1			
83	Kit, Bag Dock, <i>includes items #4a & #67</i>	09-75657-01	1	1			

Part Numbers Listing: XL2800HAY

Hypo Bag, Lights, Helping Hand Handle, 2-Speed

#	Item	Order #	Qty.	Pk.			
1d	Handle Assembly	09-75443-02	1	1			
4a	Docking Clip, Rear, Type CC (use w/#67 or order #83)	75583-03-0000	1	1			
5	Dust Bag, (8 Pk.) Hypo Allergenic	CCPK8DW	1	8			
	Dust Bag, (25 Pk.) Hypo Allergenic	CCPK25DW	1	25			
6	Outer Bag, Lt. Gray, Blk, Drk Gray	75246-10	1	1			
7	Bag Clip, Yellow/Black	09-75078-12	1	1			
8	Connector Assembly Kit, <i>includes items #3 & #84</i>	09-75308-57	1	1			
9	Collar	75309-02-0327	2	1			
10	Tube Assembly	09-75449-02	1	1			
12	Fan Housing Assembly <i>includes Rivet & Spring</i>	09-75343-03	1	1			
16	End Cap	0134623	1	1			
18	METAXALLOY™ Fan Kit w/Washers	09-75300-01	1	1			
19	Fan Cup Seal	75012-01	1	1			
20	Cord Set	see #59					
21	Lamp Housing w/Reflectors, Yellow	09-75073-10	1	1			
22	Lens	75058-01-0329	1	1			
23	Bulb	00965-0019	2	1			
24	Bulb Reflector	75034-01	4	1			
25	Lamp Holder	75539-01	1	1			
26	Housing w/Reflectors, Yellow	09-75429-08	1	1			
27	Bumper, White	75181-03	1	1			
28	Intake Pivot Assembly <i>with Felt Seal</i>	09-75066-02	1	1			
29	Felt Seal	75065-01	1	1			
32	Felt Seal, Motor	75117-01M	1	100			
33	Cord Retainer, Round Type 3 Units Only	03-00455-01	1	1			
	Cord Retainer, Square Type 4, 5, 6 & 7 Units Only	03-00494-01	1	1			
34	Motor Assembly Kit	09-75505-01	1	1			
35	Motor Seal	75095-01	2	1			
36	Kit, Motor Brush (Large & Small) / Spring	09-75514-01	2	2			
39	Drive Belt, (3 Pk.)	0300604	1	3			
39a	Drive Belt, Single	75024-01	1	1			
40	Door Belt, Yellow	75057-01-449	1	1			
42	Brush Roll, Plastic Pulley	75202-01	1	1			
43	Seal, Baseplate	75008-01	1	1			
44	Plastic Detent, (uses 2 #49 screws)	75299-01	1	1			
45	Complete Baseplate Assembly <i>includes: #43, #46, #47, #50, #51, #52, #85, #86, #87</i>	09-75715-01	1	1			
46	MICRO SWEEP Blade Type 3, 4, 5 & 6 Units Only	75009-01	1	1			
	MICRO SWEEP Blade Type 7 Units Only	75700-02	1	1			

Part Numbers Listing: XL2540RH / XL2320RH / U2640RH / U2510RH / U2520RH / U2530RH / U2540RH
Regular Bag, No Lights, Helping Hand Handle

#	Item	Order #	Qty.	Pk.			
1b	XL2540RH: Handle Assembly <i>includes items #38, #53, #54, #55, #56, #57, #59</i>	09-75288-07 ORDER 1e	1	1	NLA	NLA	NLA
	XL2320RH: Handle Assembly <i>includes items #38, #53, #54, #55, #56, #57, #59</i>	09-75288-18 ORDER 1e	1	1	NLA	NLA	NLA
1c	XL2540RH: Tortuous Grip & Cord Assembly, <i>includes items #54, #55, #59</i>	09-75342-07 ORDER 1e	1	1	NLA	NLA	NLA
1e	Kit, Retro, Handle Assembly, Residential, White, <i>includes items #38, #54, #55, #58, #59, #81, #82 Type 1, 2, 3, 4 & 5 Units Only</i>	09-75612-01	1	1			
4a	Docking Clip, Rear, Type CC (use w/#67 or order #83)	75583-03-0000	1	1			
5	Dust Bag, (8 Pk.) Regular	CCPK8	1	8			
	Dust Bag, (25 Pk.) Regular	CCPK25	1	25			
6	XL2320RH: Outer Bag, Dark Gray, Red, USA	75246-27	1	1			
	XL2540RH / U2640RH: Outer Bag, Dk Gray, Black, Dark Gray	75246-11	1	1			
	U2510RH: Outer Bag, Dark Gray, Red, Red	75246-38	1	1			
	U2520RH: Outer Bag, Dark Gray, Black, White	75246-39	1	1			
	U2530RH: Outer Bag, Dark Gray, Blue, Blue	75246-37	1	1			
	U2540RH: Outer Bag, Gray, Black, Blue	75645-28	1	1			
7	XL2540RH: Bag Clip, Dark Green	09-75078-11	1	1			
	XL2320RH: Bag Clip, Navy / Silver	09-75078-15	1	1			
	U2640RH: Bag Clip, Black / Silver	09-75078-06	1	1			
	U2510RH: Bag Clip, Red / Silver	09-75078-08	1	1			
	U2520RH: Bag Clip, White / Silver	09-75078-22	1	1			
	U2530RH: Bag Clip, Blue / Silver	09-75078-24	1	1			
	U2540RH: Bag Clip Blue / Silver	09-75594-12	1	1			
8	Connector Assembly Kit, <i>includes items #3 & #84</i>	09-75308-57	1	1			
8a	Deflector, Black, Snap Type 1 & 2 Units Only	75220-01-0327	1	1			
9	Collar	75309-02-0327	2	1			
10	Tube Assembly Type 1, 2, 3 & 4 Units Only	75188-01	1	1			
	Tube Assembly Type 5, 6 & 7 Units Only	75198-05	1	1			
12	Fan Housing Assembly <i>includes Rivet & Spring</i>	09-75343-03	1	1			
16	End Cap	0134623	1	1			
18	METAXALLOY™ Fan Kit w/Washers	09-75300-01	1	1			
19	Fan Seal Cup	75012-01	1	1			
20	Cord Set	see #59					
26	XL2320RH: Housing, Navy w/Label	09-75426-14	1	1			
	XL2540RH / U2640RH: Housing, Gull Gray w/Label	09-75426-21	1	1			
	U2510RH: Housing, Red w/Label	09-75426-23	1	1			
	U2520RH: Housing, White w/Label	09-75426-24	1	1			
	U2530RH / U2540RH: Housing, Blue w/Label	09-75780-29	1	1			
27	XL2540RH / XL2320RH / U2640RH / U2510RH / U2520RH / U2530RH: Bumper, White	75181-03	1	1			
28	Intake Pivot Assembly <i>with Felt Seal</i>	09-75066-02	1	1			
29	Felt Seal	75065-01	1	1			
32	Felt Seal, Motor	75117-01M	1	100			
33	Cord Retainer, Round Type 1, 2 & 3 Units Only	03-00455-01	1	1			
	Cord Retainer, Square Type 4, 5, 6 & 7 Units Only	03-00494-01	1	1			
34	Motor Assembly Kit	09-75505-01	1	1			
35	Motor Seal	75095-01	2	1			
36	Kit, Motor Brush (Large & Small) / Spring	09-75514-01	2	2			
39	Drive Belt, (3 Pk.)	0300604	1	3			
39a	Drive Belt, Single	75024-01	1	1			
40	XL2540RH: Door Belt, Dark Green	75057-01-439	1	1			
	XL2320RH: Door Belt, Navy	75057-01-0432	1	1			
	U2640RH: Door Belt, Gull Gray	75057-02-0384	1	1			
	U2510RH: Door Belt, Red	75057-01-441	1	1			
	U2520RH: Door Belt, White	75057-01-0431	1	1			

Part Numbers Listing: XL2540RH / XL2320RH / U2640RH / U2510RH / U2520RH / U2530RH / U2540RH cont.
 Regular Bag, No Lights, Helping Hand Handle

#	Item	Order #	Qty.	Pk.			
	U2530RH: Door Belt, Blue	75057-01-442	1	1			
	U2540RH: Door Belt, Navy	75057-01-0432	1	1			
42	Brush Roll, Plastic Pulley	75202-01	1	1			
43	Seal, Baseplate	75008-01	1	1			
44	Plastic Detent, (uses 2 #49 screws)	75299-01	1	1			
45	Complete Baseplate Assembly <i>includes: #43, #46, #47, #50, #51, #52, #85, #86, #87</i>	09-75715-01	1	1			
46	MICRO SWEEP Blade Type 1-6 Units Only	75009-01	1	1			
	MICRO SWEEP Blade Type 7 Units Only	75700-02	1	1			
47	Channel Type 1-6 Units Only	75007-02	1	1			
	Channel Type 7 Units Only	75701-01	1	1			
50	Edge Brush w/Wheel, Left Type 1-6 Units Only	09-75249-02	1	1			
	Edge Brush w/Wheel, Right Type 1-6 Units Only	09-75250-02	1	1			
	Edge Brush w/o Wheels, Left & Right	75179-03	2	1			
51	Wheel Axle	03-00630-01M	2/4*	100			
52	Soft Rear Wheel, Black	75187-02-0327	2	1			
53	Static Wire Type 1, 2, 3, 4 & 5 Units Only	75037-01	1	1			
54	XL2540RH / XL2320RH: Switch, 2 Position Assembly	75110-02	1	1			
	U2640RH / U2510RH / U2520RH / U2530RH: Switch, 2 Position Assembly	75559-01	1	1			
55	XL2540RH: Grips, Dark Green Set Type 2, 3, 4 & 5 Units Only (Type 1 Units Order Assembly 1e For Grips)	09-75301-07	1	1			
	XL2320RH: Grips, Navy Set	09-75301-21	1	1			
	U2640RH: Grips, Gull Gray Set	09-75576-29	1	1			
	U2510RH: Grips, Red Set	09-75576-28	1	1			
	U2520RH: Grips, White Set	09-75576-19	1	1			
	U2530RH: Grips, Blue Set	09-75576-30	1	1			
	U2540RH: Grips, Navy Set	09-75576-21	1	1			
56	XL2540RH: Cord Wrap Assy, <i>includes Post & Cord Wrap, Gray</i>	09-75185-09	1	1			
	XL2320RH / U2640RH / U2530RH: Cord Wrap Assy, <i>includes Post & Cord Wrap, Black</i>	09-75185-01	1	1			
	U2510RH: Cord Wrap Assy <i>includes Post & Cord Wrap, Red</i>	09-75185-07	1	1			
	U2520RH: Cord Wrap Assy <i>includes Post & Cord Wrap, White</i>	09-75185-05	1	1			
57	XL2540RH / XL2320RH / U2640RH / U2510RH / U2520RH / U2530RH: Handle Tube, Chrome	75190-03	1	1			
58	XL2540RH / XL2320RH: Cord, Harness Assembly	75081-01	1	1			
	U2640RH: Cord, Harness Assembly	75552-02-327	1	1			
	U2510RH / U2520RH / U2530RH: Cord, Harness Assembly	75552-02-328	1	1			
59	XL2540RH / XL2320RH: Cord Set, White Type 2, 3, 4 & 5 Units Only (Type 1 Units Order Assembly 1e For Cord Set)	75292-01-328	1	1			
	U2640RH: Cord Set, Black	75556-02-327	1	1			
	U2510RH / U2520RH / U2530RH / U2540RH: Cord Set, White, 30'	75556-02-328	1	1			
60	Motor Spring	75283-01	2	1			
61	Tube Label	75087-05	1	1			
65	"Oreck" Name Plate Label	75599-03	1	1			
	U2540RH: "Oreck" Name Plate Label	75599-06	1	1			
67	Bag Dock Hinge, Type CC (use w/#4a or order #83)	75582-03-0000	1	1			
	User's Manual	75416-05	1	1			
	Vacuum Cleaner Cover	VACCOVER	1	1	NLA	NLA	NLA
	Magnet Clean Vacuum Protector	MC4BK	1	1			
79	Stiffener (uses same length screws, notched)	75189-02	1	1			
	Stiffener, Through Bolt Connector (uses different length screws)	75619-01	1	1			
81	Cord Flex Relief Type 6 & 7 Units Only	03-00600-01	1	1			
83	Kit, Bag Dock, <i>includes items #4a & #67</i>	09-75657-01	1	1			
87	Front Wheel Type 7 Units Only	75709-01	2	1			

*Type 7 Units

Part Numbers Listing: XL2400RS / U2420RSQ / XL2330HS / XL2330RS / U2330RD / U2740RD

Regular Bag, No Lights, Foot Switch

#	Item	Order #	Qty.	Pk.			
1a	XL2400RS: Handle Assembly	75575-06	1	1			
	XL2330HS / XL2330RS / U2420RSQ: Handle Assembly	75575-01	1	1			
1g	U2330RD: Handle Assembly, <i>includes #38, #55, #56, #57, #82</i>	09-75093-03	1	1			
	U2740RD: Handle Assembly, <i>includes #38, #55, #56, #57, #82</i>	09-75093-01	1	1			
4a	Docking Clip, Rear, Type CC (use w/#67 or order #83)	75583-03-0000	1	1			
5	Dust Bag, (8 Pk.) Regular	CCPK8	1	8			
	Dust Bag, (25 Pk.) Regular	CCPK25	1	25			
	U2420RSQ: Dust Bag, (8pk.) Hypo	CCPK8DW	1	8			
	U2420RSQ: Dust bag, (25pk.) Hypo	CCPK25DW	1	25			
6	XL2400RS: Outer Bag, Dark Gray, Maroon, Maroon	75246-14	1	1			
	XL2330HS: Outer Bag, Lt. Gray, Black, Dark Gray	75246-10	1	1			
	XL2400RS / XL2330RS / U2330RD / U2740RD: Outer Bag, Dark Gray, Black, Dark Gray	75246-11	1	1			
	U2420RSQ: Outer Bag, Oreck hotel	75246-40	1	1			
7	XL2400RS: Bag Clip, Maroon	09-75078-10	1	1			
	XL2330HS / XL2330RS / U2330RD: Bag Clip, White	09-75078-05	1	1			
	U2740RD: Bag Clip, Black	09-75078-03	1	1			
	U2420RSQ: Bag Clip Maroon W/White	09-75078-25	1	1			
8	Connector Assembly Kit, <i>includes items #3 & #84</i>	09-75308-57	1	1			
8a	Deflector, Black, Snap Type 1 & 2 Units Only	75220-01-0327	1	1			
9	Collar	75309-02-0327	1	1			
10	Tube Assembly Type 1, 2, 3 & 4 Units Only	75188-01	1	1			
	Tube Assembly Type 5, 6 & 7 Units Only	75198-05	1	1			
11	XL2400RS / XL2330HS / XL2330RS / U2420RSQ: Grip, Handle, White	75272-01	1	1			
12	Fan Housing Assembly <i>includes Rivet & Spring</i>	09-75343-03	1	1			
13	Switch Cover	09-75266-01	1	1			
14	Switch Assembly	75084-06	1	1			
16	End Cap	0134623	1	1			
18	METAXALLOY™ Fan Kit w/Washers	09-75300-01	1	1			
19	Fan Seal Cup	75012-01	1	1			
20	Cord Set	75163-03-328	1	1			
26	XL2400RS: Housing, Maroon w/Label	09-75430-07	1	1			
	XL2330HS / XL2330RS / U2330RD: Housing, White w/Label	09-75426-18	1	1			
	U2740RD: Housing, Black w/Label	09-75430-02	1	1			
	U2420RSQ: Top Cover, Maroon	09-75426-29	1	1			
27	Bumper, White	75181-03	1	1			
28	Intake Pivot Assembly <i>with Felt Seal</i>	09-75066-02	1	1			
29	Felt Seal	75065-01	1	1			
32	Felt Seal, Motor	75117-01M	1	100			
33	Cord Retainer, Round Type 1, 2 & 3 Units Only	03-00455-01	1	1			
	Cord Retainer, Square Type 4, 5, 6 & 7 Units Only	03-00494-01	1	1			
34	Motor Assembly Kit	09-75505-01	1	1			
35	Motor Seal	75095-01	2	1			
36	Kit, Motor Brush (Large & Small) / Spring	09-75514-01	2	2			

Part Numbers Listing: XL2400RS / U2420RSQ / XL2330HS / XL2330RS / U2330RD / U2740RD cont.

Regular Bag, No Lights, Foot Switch

#	Item	Order #	Qty.	Pk.			
39	Drive Belt, (3 Pk.)	0300604	1	3			
39a	Drive Belt, Single	75024-01	1	1			
40	XL2400RS / U2420RSQ: Door Belt, Maroon	75057-01-437	1	1			
	XL2330HS / XL2330RS / U2330RD: Door Belt, White	75057-01-0431	1	1			
	U2740RD: Door Belt, Black	75057-01-0327	1	1			
42	Brush Roll, Plastic Pulley	75202-01	1	1			
43	Seal, Baseplate	75008-01	1	1			
44	Plastic Detent, (uses 2 #49 screws)	75299-01	1	1			
45	Complete Baseplate Assembly <i>includes: #43, #46, #47, #50, #51, #52, #85, #86, #87</i>	09-75715-01	1	1			
46	MICRO SWEEP Blade Type 1-6 Units Only	75009-01	1	1			
	MICRO SWEEP Blade Type 7 Units Only	75700-02	1	1			
47	Channel Type 1-6 Units Only	75007-02	1	1			
	Channel Type 7 Units Only	75701-01	1	1			
50	Edge Brush w/Wheels, Left Type 1-6 Units Only	09-75249-02	1	1			
	Edge Brush w/Wheels, Right Type 1-6 Units Only	09-75250-02	1	1			
	Edge Brush w/o Wheels, Left & Right	75179-03	2	1			
51	Wheel Axle	03-00630-01M	2/4*	100			
52	Soft Rear Wheel, Black	75187-02-0327	2	1			
55	U2330RD: Grips, White, No Switch	09-75301-25	1	1			
	U2740RD: Grips, Black, No Switch	09-75301-03	1	1			
56	U2330RD: Cord Wrap Assy, <i>includes Post & Cord Wrap</i>	09-75185-05	1	1			
	U2740RD: Cord Wrap Assy, <i>includes Post & Cord Wrap</i>	09-75185-01	1	1			
57	U2330RD / U2740RD: Handle Tube, Chrome	75190-03	1	1			
60	Motor Spring	75283-01	2	1			
61	Tube Label	75087-05	1	1			
62	Cord Bracket	75245-01	1	1			
65	"Oreck" Name Plate Label	75599-03	1	1			
	U2420RSQ: Label, Mylar Oreck	75599-06	1	1			
66	Bushing	75275-01	1	1			
67	Bag Dock Hinge, Type CC (use w/#4a or order #83)	75582-03-0000	1	1			
	User's Manual	75416-05	1	1			
	Vacuum Cleaner Cover	VACCOVER	1	1	NLA	NLA	NLA
	Magnet Clean Vacuum Protector	MC4BK	1	1			
79	Stiffener (uses same length screws, notched)	75189-02	1	1			
	Stiffener, Through Bolt Connector (uses different length screws)	75619-01	1	1			
83	Kit, Bag Dock, <i>includes items #4a & #67</i>	09-75657-01	1	1			
87	Front Wheel Type 7 Units Only	75709-01	2	1			

*Type 7 Units

Part Numbers Listing: XL2250RS / XL2260RS

Regular Bag, Lights, Foot Switch

#	Item	Order #	Qty.	Pk.			
1a	Handle Assembly	75575-01	1	1			
4a	Docking Clip, Rear, Type CC (use w/#67 or order #83)	75583-03-0000	1	1			
5	Dust Bag, (8 Pk.) Regular	CCPK8	1	8			
	Dust Bag, (25 Pk.) Regular	CCPK25	1	25			
6	Outer Bag, Dark Gray, Black, Dark Gray	75246-11	1	1			
7	Bag Clip, Gray	09-75078-07	1	1			
8	Connector Assembly Kit, <i>includes items #3 & #84</i>	09-75308-57	1	1			
8a	Deflector, Black, Snap Type 1 & 2 Units Only	75220-01-0327	1	1			
9	Collar	75309-02-0327	1	1			
10	Tube Assembly Type 1, 2, 3 & 4 Units Only	75188-01	1	1			
	Tube Assembly Type 5 & 6 Units Only	75198-05	1	1			
11	Grip, Handle, White	75272-01	1	1			
12	Fan Housing Assembly <i>includes Rivet & Spring</i>	09-75343-03	1	1			
13	Switch Cover	09-75266-01	1	1			
14	Switch Assembly	75084-06	1	1			
16	End Cap	0134623	1	1			
18	METAXALLOY™ Fan Kit w/Washers	09-75300-01	1	1			
19	Fan Seal Cup	75012-01	1	1			
20	Cord Set, White	75163-03-328	1	1			
21	Lamp Housing w/Reflectors, Gray	09-75073-08	1	1			
22	Lens	75058-01-0329	1	1			
23	Bulb	00965-0019	2	1			
24	Bulb Reflector	75034-01	4	1			
25	Lamp Holder	75539-01	1	1			
26	Housing w/Reflectors, Gray	09-75429-04	1	1			
27	Bumper, White	75181-03	1	1			
28	Intake Pivot Assembly <i>with Felt Seal</i>	09-75066-02	1	1			
29	Felt Seal	75065-01	1	1			
32	Felt Seal, Motor	75117-01M	1	100			
33	Cord Retainer, Round Type 1, 2 & 3 Units Only	03-00455-01	1	1			
	Cord Retainer, Square Type 4, 5 & 6 Units Only	03-00494-01	1	1			
34	Motor Assembly Kit	09-75505-01	1	1			
35	Motor Seal	75095-01	2	1			
36	Kit, Motor Brush (Large & Small) / Spring	09-75514-01	2	2			
39	Drive Belt, (3 Pk.)	0300604	1	3			
39a	Drive Belt, Single	75024-01	1	1			
40	Door Belt, Gray	75057-01-436	1	1			
42	Brush Roll, Plastic Pulley	75202-01	1	1			
43	Seal, Baseplate	75008-01	1	1			

Part Numbers Listing: XL2500RH, XL2500HH

Lights, Helping Hand Handle

#	Item	Order #	Qty.	Pk.			
1b	XL2500RH: Handle Assembly <i>includes items #38, #53, #54, #55, #56, #57, #59</i>	09-75288-07 ORDER 1e	1	1	NLA	NLA	NLA
	XL2500HH: Handle Assembly <i>includes items #38, #53, #54, #55, #56, #57, #59</i>	09-75288-11 ORDER 1e	1	1	NLA	NLA	NLA
1c	Tortuous Grip & Cord Assembly, <i>includes items #54, #55, #59</i>	09-75342-07	1	1	NLA	NLA	NLA
1e	Kit, Retro, Handle Assembly, Residential, White, <i>includes items #38, #54, #55, #58, #59, #81, #82 Type 1, 2, 3, 4 & 5 Units Only</i>	09-75612-01	1	1			
4a	Docking Clip, Rear, Type CC (use w/#67 or order #83)	75583-03-0000	1	1			
5	Dust Bag, (8 Pk.) Regular	CCPK8	1	8			
	Dust Bag, (25 Pk.) Regular	CCPK25	1	25			
	Dust Bag, (8 Pk.) Hypo Allergenic	CCPK8DW	1	8			
	Dust Bag, (25 Pk.) Hypo Allergenic	CCPK25DW	1	25			
6	XL2500RH: Outer Bag, Drk Gray, Black, Dark Gray	75246-11	1	1			
	XL2500HH: Outer Bag, Lt. Gray, Black, Gray	75246-10	1	1			
7	Bag Clip, Dark Green	09-75078-11	1	1			
8	Connector Assembly Kit, <i>includes items #3 & #84</i>	09-75308-57	1	1			
8a	Deflector, Black, Snap Type 1 & 2 Units Only	75220-01-0327	1	1			
9	Collar	75309-02-0327	2	1			
10	Tube Assembly Type 1, 2, 3 & 4 Units Only	75188-01	1	1			
	Tube Assembly Type 5 Units Only	75198-05	1	1			
12	Fan Housing Assembly <i>includes Rivet & Spring</i>	09-75343-03	1	1			
16	End Cap	0134623	1	1			
18	METAXALLOY™ Fan Kit w/Washers	09-75300-01	1	1			
19	Fan Seal Cup	75012-01	1	1			
20	Cord Set	see #59					
21	Lamp Housing w/Reflectors, Dark Green	09-75073-09	1	1			
22	Lens	75058-01-0329	1	1			
23	Bulb	00965-0019	2	1			
24	Bulb Reflector	75034-01	4	1			
25	Lamp Holder	75539-01	1	1			
26	Housing w/Reflectors, Dark Green	09-75270-05	1	1			
27	Bumper, White	75181-03	1	1			
28	Intake Pivot Assembly <i>with Felt Seal</i>	09-75066-02	1	1			
29	Felt Seal	75065-01	1	1			
32	Felt Seal, Motor	75117-01M	1	100			
33	Cord Retainer	03-00455-01	1	1			
34	Motor Assembly Kit	09-75505-01	1	1			
35	Motor Seal	75095-01	2	1			
36	Kit, Motor Brush (Large & Small) / Spring	09-75514-01	2	2			
39	Drive Belt, (3 Pk.)	0300604	1	3			
39a	Drive Belt, Single	75024-01	1	1			

Part Numbers Listing: XL2200RS / U2200RD / XL2300RS / XL2310RS / U2310RSF / U2310RD

Regular Bag, No Lights, Foot Switch

#	Item	Order #	Qty.	Pk.			
1a	XL2200RS / XL2310RS / U2310RSF: Handle Assembly	75575-01	1	1			
	XL2300RS: Handle Assembly - Clear Tube, (Black Tube NLA)	75575-02	1	1			
1g	U2200RD: Handle Assembly, <i>includes #38, #55, #56, #57, #82</i>	09-75093-02	1	1			
	U2310RD: Handle Assembly, <i>includes #38, #55, #56, #57, #82</i>	09-75093-05	1	1			
4a	Docking Clip, Rear, Type CC (use w/#67 or order #83)	75583-03-0000	1	1			
5	Dust Bag, (8 Pk.) Regular	CCPK8	1	8			
	Dust Bag, (25 Pk.) Regular	CCPK25	1	25			
6	XL2200RS / U2200RD / XL2300RS / XL2310RS / U2310RD / U2310RSF: Outer Bag, Dk Gray, Black, Dk Gray	75246-11	1	1			
	XL2310RSB: Outer Bag, Dk Gray, Blue, Buck Master	75246-33	1	1			
	U2310RSF: Outer Bag, Dk Gray, Red, USA	75246-27	1	1			
7	XL2200RS / U2200RD: Bag Clip, Gray	09-75078-10	1	1			
	XL2300RS: Bag Clip, Black	09-75078-06	1	1			
	XL2310RS / U2310RSF / U2310RD: Bag Clip, Navy	09-75078-15	1	1			
8	Connector Assembly Kit, <i>includes items #3 & #84</i>	09-75308-57	1	1			
8a	Deflector, Black, Snap Type 1 & 2 Units Only	75220-01-0327	1	1			
9	Collar	75309-02-0327	1	1			
10	Tube Assembly Type 1, 2, 3 & 4 Units Only	75188-01	1	1			
	Tube Assembly Type 5, 6 & 7 Units Only	75198-05	1	1			
11	XL2200RS / XL2310RS: Grip, Handle, White	75272-01	1	1			
	XL2300RS / U2310RSF: Grip, Handle, Black	75272-02	1	1			
12	Fan Housing Assembly <i>includes Rivet & Spring</i>	09-75343-03	1	1			
13	Switch Cover	09-75266-01	1	1			
14	Switch Assembly	75084-06	1	1			
16	End Cap	0134623	1	1			
18	METAXALLOY™ Fan Kit w/Washers	09-75300-01	1	1			
19	Fan Seal Cup	75012-01	1	1			
20	XL2200RS / U2200RD / XL2310RS / U2310RSF: Cord Set	75163-03-328	1	1			
	XL2300RS: Cord Set	75079-02	1	1			
26	XL2200RS / U2200RD: Housing, Gray w/Label	09-75430-01	1	1			
	XL2300RS: Housing, Black w/Label	09-75430-02	1	1			
	XL2310RS / U2310RSF / U2310RD: Housing, Navy w/Label	09-75426-13	1	1			
27	Bumper, White	75181-03	1	1			
28	Intake Pivot Assembly <i>with Felt Seal</i>	09-75066-02	1	1			
29	Felt Seal	75065-01	1	1			
32	Felt Seal, Motor	75117-01M	1	100			
33	XL2200RS: Cord Retainer, Round Type 1, 2 & 3 Units Only	03-00455-01	1	1			
	XL2300RS: Cord Retainer, Round Type 1, 2 & 3 Units Only	03-00455-02	1	1			
	Cord Retainer, Square Type 4, 5, 6 & 7 Units Only	03-00494-01	1	1			
34	Motor, Assembly Kit	09-75505-01	1	1			

Part Numbers Listing: XL2200RS / U2200RD / XL2300RS / XL2310RS / U2310RSF / U2310RD cont.

Regular Bag, No Lights, Foot Switch

#	Item	Order #	Qty.	Pk.			
35	Motor Seal	75095-01	2	1			
36	Kit, Motor Brush (Large & Small) / Spring	09-75514-01	2	2			
39	Drive Belt, (3 Pk.)	0300604	1	3			
39a	Drive Belt, Single	75024-01	1	1			
40	XL2200RS / U2200RD: Door Belt, Gray	75057-01-436	1	1			
	XL2300RS: Door Belt, Black	75057-01-0327	1	1			
	XL2310RS / U2310RSF / U2310RD: Door Belt, Navy	75057-01-0432	1	1			
42	Brush Roll, Plastic Pulley	75202-01	1	1			
43	Seal, Baseplate	75008-01	1	1			
44	Plastic Detent, (uses 2 #49 screws)	75299-01	1	1			
45	Complete Baseplate Assembly <i>includes: #43, #46, #47, #50, #51, #52, #85, #86, #87</i>	09-75715-01	1	1			
46	MICRO SWEEP Blade Type 1-6 Units Only	75009-01	1	1			
	MICRO SWEEP Blade Type 7 Units Only	75700-02	1	1			
47	Channel Type 1-6 Units Only	75007-02	1	1			
	Channel Type 7 Units Only	75701-01	1	1			
50	Edge Brush w/Wheels, Left Type 1-6 Units Only	09-75249-02	1	1			
	Edge Brush w/Wheels, Right Type 1-6 Units Only	09-75250-02	1	1			
	Edge Brush w/o Wheels, Left & Right	75179-03	2	1			
51	Wheel Axle	03-00630-01M	2/4*	100			
52	Soft Rear Wheel, Black	75187-02-0327	2	1			
55	U2200RD: Grips, Lt. Gray, No Switch	09-75301-24	1	1			
	U2310RD: Grips, Navy, No Switch	09-75301-26	1	1			
56	U2200RD / U2310RD: Cord Wrap Assy, <i>includes Post & Cord Wrap</i>	09-75185-01	1	1			
57	U2200RD / U2310RD: Handle Tube, Chrome	75190-03	1	1			
60	Motor Spring	75283-01	2	1			
61	Tube Label	75087-05	1	1			
62	Cord Bracket	75245-01	1	1			
65	"Oreck" Name Plate Label	75599-03	1	1			
66	Bushing	75275-01	1	1			
67	Bag Dock Hinge, Type CC (use w/#4a or order #83)	75582-03-0000	1	1			
	User's Manual	75416-05	1	1			
	Vacuum Cleaner Cover	VACCOVER	1	1	NLA	NLA	NLA
	Magnet Clean Vacuum Protector	MC4BK	1	1			
79	Stiffener (uses same length screws, notched)	75189-02	1	1			
	Stiffener, Through Bolt Connector (uses different length screws)	75619-01	1	1			
83	Kit, Bag Dock, <i>includes items #4a & #67</i>	09-75657-01	1	1			
87	Front Wheel Type 7 Units Only	75709-01	2	1			

*Type 7 Units

Part Numbers Listing: XL2450RH

Lights, Helping Hand Handle

#	Item	Order #	Qty.	Pk.			
1b	Handle Assembly <i>includes items #38, #53, #54, #55, #56, #57, #59</i>	09-75298-62 ORDER 1e	1	1	NLA	NLA	NLA
1e	Kit, Retro, Handle Assembly, Residential, White, <i>includes items #38, #54, #55, #58, #59, #81, #82 Type 1, 2, 3, 4 & 5 Units Only</i>	09-75612-01	1	1			
4a	Docking Clip, Rear, Type CC (use w/#67 or order #83)	75583-03-0000	1	1			
5	Dust Bag, (8 Pk.) Regular	CCPK8	1	8			
	Dust Bag, (25 Pk.) Regular	CCPK25	1	25			
	Dust Bag, (8 Pk.) Hypo Allergenic	CCPK8DW	1	8			
	Dust Bag, (25 Pk.) Hypo Allergenic	CCPK25DW	1	25			
6	Outer Bag, Grey, Maroon, Maroon	75246-20	1	1			
7	Bag Clip, Maroon	09-75078-13	1	1			
8	Connector Assembly Kit, <i>includes items #3 & #84</i>	09-75308-57	1	1			
9	Collar	75309-02-0327	2	1			
10	Tube Assembly Type 1, 2, 3 & 4 Units Only	75188-01	1	1			
	Tube Assembly Type 5 Units Only	75198-05	1	1			
12	Fan Housing Assembly <i>includes Rivet & Spring</i>	09-75343-03	1	1			
16	End Cap	0134623	1	1			
18	METAXALLOY™ Fan Kit w/Washers	09-75300-01	1	1			
19	Fan Seal Cup	75012-01	1	1			
20	Cord Set	see #59					
21	Lamp Housing w/Reflectors, Maroon	09-75073-61	1	1			
22	Lens	75058-01-0329	1	1			
23	Bulb	00965-0019	2	1			
24	Bulb Reflector	75034-01	4	1			
25	Lamp Holder	75539-01	1	1			
26	Housing w/Reflectors, Light Gray	09-75429-03	1	1			
27	Bumper, White	75181-03	1	1			
28	Intake Pivot Assembly <i>with Felt Seal</i>	09-75066-02	1	1			
29	Felt Seal	75065-01	1	1			
32	Felt Seal, Motor	75117-01M	1	100			
33	Cord Retainer, Round Type 1, 2 & 3 Units Only	03-00455-02	1	1			
	Cord Retainer, Square Type 4 & 5 Units Only	03-00494-01	1	1			
34	Motor Assembly Kit	09-75505-01	1	1			
35	Motor Seal	75095-01	2	1			
36	Kit, Motor Brush (Large & Small) / Spring	09-75514-01	2	2			
39	Drive Belt, (3 Pk.)	0300604	1	3			
39a	Drive Belt, Single	75024-01	1	1			
40	Door Belt, Maroon	75057-01-437	1	1			
42	Brush Roll, Plastic Pulley	75202-01	1	1			
43	Seal, Baseplate	75008-01	1	1			
44	Plastic Detent, (uses 2 #49 screws)	75299-01	1	1			

Part Numbers Listing: XL2000HH / XL2100HH / U2000HH

Hypo Bag, Helping Hand Handle, Commercial, No Lights

#	Item	Order #	Qty.	Pk.			
1b	XL2000HH: Handle Assembly, <i>includes items #38, #53, #54, #55, #56, #57, #59 Type 1, 2, 3, 4 & 5 Units Only</i>	09-75288-05 ORDER 1e	1	1	NLA	NLA	NLA
	XL2100HH: Handle Assembly, <i>includes items #38, #53, #54, #55, #56, #57, #59 Type 1, 2, 3, 4 & 5 Units Only</i>	09-75288-06 ORDER 1e	1	1	NLA	NLA	NLA
1c	XL2000HH: Tortuous Grip & Cord Assembly, <i>includes items #54, #55, #59 Type 1 Units Only</i>	09-75342-05	1	1	NLA	NLA	NLA
	XL2100HH: Tortuous Grip & Cord Assembly, <i>includes items #54, #55, #59 Type 1 Units Only</i>	09-75342-06	1	1	NLA	NLA	NLA
1e	Kit, Retro, Handle Assembly, Commercial, Red, <i>includes items #38, #54, #55, #58, #59, #81, #82 Type 1, 2, 3, 4 & 5 Units Only</i>	09-75611-01	1	1			
1f	Kit, Retro, Handle Assembly, Commercial, Red, <i>includes items #38, #53, #54, #55, #56, #57, #58, #59, #80, #81</i>	09-75562-09	1	1			
4	Bag Retainer Spring	75035-02	1	1			
5	Dust Bag, (9 Pk.) Hypo Allergenic	PK80009DW	1	9			
	Dust Bag, (25 Pk.) Hypo Allergenic	PK800025DW	1	25			
6	XL2000HH: Outer Bag, Lt. Gray, Red, Red	75246-15	1	1			
	XL2100HH: Outer Bag, Lt. Gray, Blue, Blue	75246-17	1	1			
	U2000HH: Outer Bag, Lt. Gray, Red, Red	75246-15	1	1			
7	XL2000HH / U2000HH: Bag Clip, Red	09-75078-08	1	1			
	XL2100HH: Bag Clip, Blue	09-75078-09	1	1			
8	Connector Assembly Kit, <i>includes items #3 & #84</i>	09-75308-57	1	1			
8a	Deflector, Black, Snap Type 1 & 2 Units Only	75220-01-0327	1	1			
9	Collar	75309-02-0327	2	1			
10	Tube Assembly Type 1, 2, 3 & 4 Units Only	75188-01	1	1			
	Tube Assembly Type 5, 6 & 7 Units Only	75198-05	1	1			
12	Fan Housing Assembly <i>includes Rivet & Spring</i>	09-75343-03	1	1			
16	End Cap	0134623	1	1			
18	METAXALLOY™ Fan Kit w/Washers	09-75300-01	1	1			
19	Fan Cup Seal	75012-01	1	1			
20	Cord Set	<i>see #59</i>					
26	XL2000HH / U2000HH: Housing, Red, w/Label	09-75430-03	1	1			
	U2000HH: Housing, Red, Rapid Replacement Type 7 Units Only	09-75426-26	1	1			
	XL2100HH: Housing, Blue, w/Label	09-75430-05	1	1			
27	Bumper, Clear	75181-04	1	1			
28	Intake Pivot Assembly, <i>with Felt Seal</i>	09-75066-02	1	1			
29	Felt Seal	75065-01	1	1			
32	Felt Seal, Motor	75117-01M	1	100			
33	Cord Retainer, Round Type 1, 2 & 3 Units Only	03-00457-01	1	1			
	Cord Retainer, Square Type 4, 5, 6 & 7 Units Only	03-00494-01	1	1			
34	Motor Assembly Kit	09-75505-01	1	1			
35	Motor Seal	75095-01	2	1			
36	Kit, Motor Brush (Large & Small) / Spring	09-75514-01	2	2			
39	Drive Belt, (3 Pk.)	0300604	1	3			
39a	Drive Belt, Single	75024-01	1	1			

Part Numbers Listing: XL2000HH / XL2100HH / U2000HH cont.

Hypo Bag, Helping Hand Handle, Commercial, No Lights

#	Item	Order #	Qty.	Pk.			
40	XL2000HH / U2000HH: Door Belt, Red	75057-01-441	1	1			
	XL2100HH: Door Belt, Blue	75057-01-438	1	1			
42	Brush Roll, Plastic Pulley	75202-01	1	1			
43	Seal, Baseplate	75008-01	1	1			
44	Plastic Detent, (uses 2 #49 screws)	75299-01	1	1			
45	Complete Baseplate Assembly, Commercial <i>includes: #43, #46, #47, #50, #51, #52, #85, #86, #87</i>	09-75715-03	1	1			
46	MICRO SWEEP Blade Type 1-6 Units Only	75009-01	1	1			
	MICRO SWEEP Blade Type 7 Units Only	75700-02	1	1			
47	Channel Type 1-6 Units Only	75007-02	1	1			
	Channel Type 7 Units Only	75701-01	1	1			
50	Edge Brush, w/o wheels	75179-03	2	1			
51	Wheel Axle	03-00630-01M	2/4*	100			
52	Soft Rear Wheel, Black	75187-02-0327	2	1			
53	Static Wire Type 1, 2, 3, 4 & 5 Units Only	75037-01	1	1			
54	Switch, 2 Position Assembly Type 1, 2, 3, 4 & 5 Units Only	75110-02	1	1			
	Switch, 2 Position Assembly Type 6 & 7 Units Only	75559-01	1	1			
55	XL2000HH: Grips, Red Set Type 2, 3, 4 & 5 Units Only (Type 1 Units Order Assembly 1e For Grips)	09-75301-08	1	1			
	XL2000HH / U2000HH: Grips, Red Set Type 6 & 7 Units Only	09-75576-08	1	1			
	XL2100HH: Grips, Blue Set Type 2, 3, 4 & 5 Units Only (Type 1 Units Order Assembly 1e For Grips)	09-75301-06	1	1			
	XL2100HH: Grips, Blue Set Type 6 & 7 Units Only	09-75576-06	1	1			
56	XL2000HH / U2000HH: Cord Wrap Assy, <i>includes Post & Cord Wrap</i>	09-75185-07	1	1			
	XL2100HH: Cord Wrap Assy, <i>includes Post & Cord Wrap</i>	09-75185-08	1	1			
57	XL2000HH: Handle Tube, Chrome	75190-03	1	1			
	XL2100HH / U2000HH: Handle Tube, Black	75190-04	1	1			
58	Cord, Harness Assembly, Black Type 1, 2, 3, 4 & 5 Units Only	75082-02	1	1			
	Cord, Harness Assembly, Red Type 6 & 7 Units Only	75557-03-441	1	1			
59	Cord Set, Black Type 2, 3, 4 & 5 Units Only (Type 1 Units Order Assembly 1e For Cord Set)	75294-01-327	1	1			
	Cord Set, Red w/ #81 Type 6 & 7 Units Only	75558-02-441	1	1			
60	Motor Spring	75283-01	2	1			
61	Tube Label	75087-05	1	1			
65	"Oreck Commercial" Name Plate Label	75599-02	1	1			
	"Rapid Replacement" Name Plate Label	75599-05	1	1			
76	Handle Brace	75432-01	1	1			
76a	Handle Brace Kit	75435-01	1	1			
	User's Manual	75417-05	1	1			
	Magnet Clean Vacuum Protector	MC4BK	1	1			
79	Stiffener (uses same length screws, notched)	75189-02	1	1			
	Stiffener, Through Bolt Connector (uses different length screws)	75619-01	1	1			
81	Cord Flex Relief Type 6 & 7 Units Only	03-00600-01	1	1			
87	Front Wheel Type 7 Units Only	75709-01	2	1			

*Type 7 Units

Part Numbers Listing: XL2000RH, XL2100RH, XL2090RHM & XL2070RH
 Regular Bag, Helping Hand Handle, Commercial, No Lights

#	Item	Order #	Qty.	Pk.			
1b	XL2000RH: Handle Assembly, <i>includes items #38, #53, #54, #55, #56, #57, #59 Type 1, 2, 3, 4 & 5 Units Only</i>	09-75288-05 ORDER 1e	1	1	NLA	NLA	NLA
	XL2100RH: Handle Assembly, <i>includes items #38, #53, #54, #55, #56, #57, #59 Type 1, 2, 3, 4 & 5 Units Only</i>	09-75288-06 ORDER 1e	1	1	NLA	NLA	NLA
	XL2090RHM: Handle Assembly, <i>includes items #38, #53, #54, #55, #56, #57, #59 Type 1, 2, 3, 4 & 5 Units Only</i>	09-75288-08 ORDER 1e	1	1	NLA	NLA	NLA
1c	XL2000RH: Tortuous Grip & Cord Assembly, <i>includes items #54, #55, #59 Type 1 Units Only</i>	09-75342-05	1	1	NLA	NLA	NLA
	XL2100RH: Tortuous Grip & Cord Assembly, <i>includes items #54, #55, #59 Type 1 Units Only</i>	09-75342-06	1	1	NLA	NLA	NLA
	XL2090RHM: Tortuous Grip & Cord Assembly, <i>includes items #54, #55, #59 Type 1 Units Only</i>	09-75342-09	1	1	NLA	NLA	NLA
1e	Kit, Retro, Handle Assembly, Commercial, Red, <i>includes items #38, #54, #55, #58, #59, #81, #82 Type 1, 2, 3, 4 & 5 Units Only</i>	09-75611-01	1	1			
1f	Kit, Retro, Handle Assembly, Commercial, Red, <i>includes items #38, #53, #54, #55, #56, #57, #58, #59, #81, #82</i>	09-75562-09	1	1			
	XL2090RHM: Kit, Retro, Handle Assembly, Commercial, Green, <i>includes items #38, #53, #54, #55, #56, #57, #58, #59, #81, #82</i>	09-75562-58	1	1			
4	Bag Retainer Spring	75035-02	1	1			
5	Dust Bag, (9 Pk.) Regular	PK80009	1	9			
	Dust Bag, (25 Pk.) Regular	PK800025	1	25			
6	XL2000RH: Outer Bag, Drk. Gray, Red, Red, Commercial	75246-16	1	1			
	XL2100RH: Outer Bag, Drk. Blue, Blue, Blue	75246-18	1	1			
	XL2090RHM: Outer Bag, Merry Maids	75246-08	1	1			
	XL2070RH: Outer Bag, Gray, White, Turquoise	75246-34	1	1			
7	XL2000RH: Bag Clip, Red	09-75078-08	1	1			
	XL2100RH: Bag Clip, Blue	09-75078-09	1	1			
	XL2090RHM: Bag Clip, Kelly Green	09-75078-01	1	1			
	XL2070RH: Bag Clip, Turquoise	09-75078-20	1	1			
8	Connector Assembly Kit, <i>includes items #3 & #84</i>	09-75308-57	1	1			
8a	Deflector, Black, Snap Type 1 & 2 Units Only	75220-01-0327	1	1			
9	Collar	75309-02-0327	2	1			
10	Tube Assembly Type 1, 2, 3 & 4 Units Only	75188-01	1	1			
	Tube Assembly Type 5, 6 & 7 Units Only	75198-05	1	1			
12	Fan Housing Assembly <i>includes Rivet & Spring</i>	09-75343-03	1	1			
16	End Cap, Left	0134623	1	1			
18	METAXALLOY™ Fan Kit w/Washers	09-75300-01	1	1			
19	Fan Cup Seal	75012-01	1	1			
20	Cord Set	<i>see #59</i>					
26	XL2000RH: Housing, Red, w/Label Type 1, 2, 3, 4 & 5 Units Only	09-75430-03	1	1			
	XL2000RH: Housing, Red, Rapid Replacement Type 7 Units Only	09-75426-26	1	1			
	XL2000RH: Housing, Gray, Rapid Replacement Restauranteur Type 6 & 7 Units Only	09-75426-27	1	1			
	XL2100RH: Housing, Blue, w/Label	09-75430-05	1	1			
	XL2090RHM: Housing, Kelly Green, w/Label	09-75430-17	1	1			
	XL2070RH: Housing, Turquoise w/Label	09-75426-17	1	1			
27	Bumper, Clear	75181-04	1	1			
28	Intake Pivot Assembly, <i>with Felt Seal</i>	09-75066-02	1	1			
29	Felt Seal	75065-01	1	1			
32	Felt Seal, Motor	75117-01M	1	100			
33	Cord Retainer, Round Type 1, 2 & 3 Units Only	03-00457-01	1	1			
	Cord Retainer, Square Type 4, 5, 6 & 7 Units Only	03-00494-01	1	1			
34	Motor Assembly Kit	09-75505-01	1	1			
35	Motor Seal	75095-01	2	1			
36	Kit, Motor Brush (Large & Small) / Spring	09-75514-01	2	2			
39	Drive Belt, (3 Pk.)	0300604	1	3			
39a	Drive Belt, Single	75024-01	1	1			
40	XL2000RH: Door, Belt, Red	75057-01-441	1	1			
	XL2000RH: Door, Belt, Gray Type 6 Units Only	75057-01-0384	1	1			
	XL2100RH: Door, Belt, Blue	75057-01-438	1	1			
	XL2090RHM: Door, Belt, Kelly Green	75057-01-0433	1	1			
	XL2070RH: Door, Belt, Turquoise	75057-01-458	1	1			

Part Numbers Listing: XL2000RH, XL2100RH, XL2090RHM & XL2070RH cont.

Regular Bag, Helping Hand Handle, Commercial, No Lights

#	Item	Order #	Qty.	Pk.			
42	XL2000RH / XL2100RH / XL2070RH: Brush Roll, Plastic Pulley	75202-01	1	1			
	XL2090RHM: Brush Roll, Metal Pulley	75104-02	1	1			
42a	XL2090RHM: Endcard, Metal Pulley Side, Left	75705-01	1	1			
42b	XL2090RHM: Brush Roll Pulley, Metal	75706-01	1	1			
43	Seal, Baseplate	75008-01	1	1			
44	Plastic Detent, (uses 2 #49 screws)	75299-01	1	1			
45	Complete Baseplate Assembly, Commercial <i>includes: #43, #46, #47, #50, #51, #52, #85, #86, #87</i>	09-75715-03	1	1			
46	MICRO SWEEP Blade Type 1-6 Units Only	75009-01	1	1			
	MICRO SWEEP Blade Type 7 Units Only	75700-02	1	1			
47	Channel Type 1-6 Units Only	75007-02	1	1			
	Channel Type 7 Units Only	75701-01	1	1			
50	Edge Brush, w/o wheels	75179-03	2	1			
51	Wheel Axle	03-00630-01M	2/4*	100			
52	Soft Rear Wheel, Black	75187-02-0327	2	1			
53	Static Wire Type 1, 2, 3, 4 & 5 Units Only	75037-01	1	1			
54	Switch, 2 Position Assembly Type 1, 2, 3, 4 & 5 Units Only	75110-02	1	1			
	Switch, 2 Position Assembly Type 6 & 7 Units Only	75559-01	1	1			
55	XL2000RH: Grips, Red Set Type 2, 3, 4 & 5 Units Only (Type 1 Units Order Assembly 1e For Grips)	09-75301-08	1	1			
	XL2000RH: Grips, Red Set Type 6 & 7 Units Only	09-75576-08	1	1			
	XL2100RH: Grips, Blue Set Type 2, 3, 4 & 5 Units Only (Type 1 Units Order Assembly 1e For Grips)	09-75301-06	1	1			
	XL2100RH: Grips, Blue Set Type 6 & 7 Units Only	09-75576-06					
	XL2090RHM: Grips, Kelly Green Type 2, 3, 4 & 5 Units Only (Type 1 Units Order Assembly 1e For Grips)	09-75301-05	1	1			
	XL2090RHM: Grips, Kelly Green Set Type 6 & 7 Units Only	09-75576-05	1	1			
	XL2070RH: Grips, Turquoise Set Type 6 & 7 Units Only	09-75576-25	1	1			
56	XL2000RH: Cord Wrap Assy, <i>includes Post & Cord Wrap</i>	09-75185-07	1	1			
	XL2100RH: Cord Wrap Assy, <i>includes Post & Cord Wrap</i>	09-75185-08	1	1			
	XL2090RHM: Cord Wrap Assy, <i>includes Post & Cord Wrap</i>	09-75185-03	1	1			
	XL2070RH: Cord Wrap Assy, <i>includes Post & Cord Wrap</i>	09-75185-05	1	1			
57	XL2000RH / XL2070RH: Handle Tube	75190-04	1	1			
	XL2100RH / XL2090RHM: Handle Tube	75190-03	1	1			
58	XL2000RH / XL2100RH: Cord, Harness Assembly, Black Type 1, 2, 3, 4 & 5 Units Only	75082-02	1	1			
	XL2000RH / XL2100RH: Cord, Harness Assembly, Red Type 6 & 7 Units Only	75557-03-441	1	1			
	XL2090RHM: Cord, Harness Assembly, Black Type 1, 2, 3, 4 & 5 Units Only	75082-02	1	1			
	XL2090RHM / XL2070RH: Cord, Harness Assy, White Type 6 & 7 Units Only	75557-03-328	1	1			
59	XL2100RH / XL2000RH: Cord Set, Red w/ #81 Type 6 & 7 Units Only	75558-02-441	1	1			
	XL2000RH / XL2100RH / XL2090RHM: Cord Set, Black Type 2, 3, 4 & 5 Units Only (Type 1 Units Order Assembly 1e For Cord Set)	75294-01-327	1	1			
	XL2090RHM / XL2070RH: Cord Set, White w/ #81 Type 6 & 7 Units Only	75558-02-328	1	1			
60	Motor Spring	75283-01	2	1			
61	Tube Label	75087-05	1	1			
65	"Oreck Commercial" Name Plate Label	75599-02	1	1			
	"Rapid Replacement Restaurateur" Name Plate Label	75599-04	1	1			
	"Rapid Replacement" Name Plate Label	75599-05	1	1			
76	Handle Brace	75432-01	1	1			
76a	Handle Brace Kit	75435-01	1	1			
	User's Manual	75417-05	1	1			
	Magnet Clean Vacuum Protector	MC4BK	1	1			
79	Stiffener (uses same length screws, notched)	75189-02	1	1			
	Stiffener, Through Bolt Connector (uses different length screws)	75619-01	1	1			
81	Cord Flex Relief Type 6 & 7 Units Only	03-00600-01	1	1			
87	Front Wheel Type 7 Units Only	75709-01	2	1			

Part Numbers Listing: XL2000RS, XL2100RS & XL2090RSM

Regular Bag, Foot Switch, Commercial, No Lights

#	Item	Order #	Qty.	Pk.			
1a	XL2000RS: Handle Assembly	75575-04	1	1			
	XL2100RS: Handle Assembly	75575-05	1	1			
	XL2090RSM: Handle Assembly	75575-02	1	1			
4	Bag Retainer Spring	75035-02	1	1			
5	Dust Bag, (9 Pk.) Regular	PK80009	1	9			
	Dust Bag, (25 Pk.) Regular	PK800025	1	25			
6	XL2000RS: Outer Bag, Drk. Gray, Red, Red	75246-16	1	1			
	XL2100RS: Outer Bag, Drk. Blue, Blue, Blue	75246-18	1	1			
	XL2090RSM: Outer Bag, Merry Maids	75246-08	1	1			
7	XL2000RS: Bag Clip, Red	09-75078-08	1	1			
	XL2100RS: Bag Clip, Blue	09-75078-09	1	1			
	XL2090RSM: Bag Clip, Kelly Green	09-75078-01	1	1			
8	Connector Assembly Kit, <i>includes items #3 & #84</i>	09-75308-57	1	1			
8a	Deflector, Black, Snap Type 1 & 2 Units Only	75220-01-0327	1	1			
9	Collar	75309-02-0327	1	1			
10	Tube Assembly Type 1, 2, 3, & 4 Units Only	75188-01	1	1			
	Tube Assembly Type 5, 6 & 7 Units Only	75198-05	1	1			
11	XL2000RS: Grip, Handle, Red	75272-03	1	1			
	XL2100RS: Grip, Handle, White	75272-01	1	1			
	XL2090RSM: Grip, Handle, Black	75272-02	1	1			
12	Fan Housing Assembly <i>includes Rivet & Spring</i>	09-75343-03	1	1			
13	Switch Cover	09-75266-01	1	1			
14	Switch Assembly	75084-05	1	1			
16	End Cap	0134623	1	1			
18	METAXALLOY™ Fan Kit w/Washers	09-75300-01	1	1			
19	Fan Seal Cup	75012-01	1	1			
20	XL2000RS / XL2100RS: Cord Set, Red	75080-05-441	1	1			
	XL2090RSM: Cord Set, White	75080-05-328	1	1			
26	XL2000RS: Housing, Red, w/Label	09-75430-04	1	1			
	XL2100RS: Housing, Blue, w/Label	09-75430-06	1	1			
	XL2090RSM: Housing, Kelly Green, w/Label	09-75430-16	1	1			
27	Bumper, Clear	75181-04	1	1			
28	Intake Pivot Assembly <i>with Felt Seal</i>	09-75066-02	1	1			
29	Felt Seal	75065-01	1	1			
32	Felt Seal, Motor	75117-01M	1	100			
33	Cord Retainer, Round Type 1, 2 & 3 Units Only	03-00457-01	1	1			
	Cord Retainer, Square Type 4, 5, 6 & 7 Units Only	03-00494-01	1	1			
34	Motor Assembly Kit	09-75505-01	1	1			

Part Numbers Listing: XL2000RS, XL2100RS & XL2090RSM cont.

Regular Bag, Foot Switch, Commercial, No Lights

#	Item	Order #	Qty.	Pk.			
35	Motor Seal	75095-01	2	1			
36	Kit, Motor Brush (Large & Small) / Spring	09-75514-01	2	2			
39	Drive Belt, (3 Pk.)	0300604	1	3			
39a	Drive Belt, Single	75024-01	1	1			
40	XL2000RS: Door Belt, Red	75057-01-441	1	1			
	XL2100RS: Door Belt, Blue	75057-01-438	1	1			
	XL2090RSM: Door Belt, Kelly Green	75057-01-0433	1	1			
42	XL2000RS / XL2100RS: Brush Roll, Plastic Pulley	75202-01	1	1			
	XL2090RSM: Brush Roll, Metal Pulley	75104-02	1	1			
42a	XL2090RSM: Endcard, Metal Pulley Side, Left	75705-01	1	1			
42b	XL2090RSM: Brush Roll Pulley, Metal	75706-01	1	1			
43	Seal, Baseplate	75008-01	1	1			
44	Plastic Detent, (uses 2 #49 screws)	75299-01	1	1			
45	Complete Baseplate Assembly, Commercial <i>includes: #43, #46, #47, #50, #51, #52, #85, #86, #87</i>	09-75715-03	1	1			
46	MICRO SWEEP Blade Type 1-6 Units Only	75009-01	1	1			
	MICRO SWEEP Blade Type 7 Units Only	75700-02	1	1			
47	Channel Type 1-6 Units Only	75007-02	1	1			
	Channel Type 7 Units Only	75701-01	1	1			
50	Edge Brush, w/o wheels	75179-03	2	1			
51	Wheel Axle	03-00630-01M	2/4*	100			
52	Soft Rear Wheel, Black	75187-02-0327	2	1			
60	Motor Spring	75283-01	2	1			
61	Tube Label	75087-05	1	1			
62	XL2000RS: Cord Bracket	75245-02	1	1			
	XL2100RS: Cord Bracket	75245-01	1	1			
	XL2090RSM: Cord Bracket	75245-02	1	1			
65	"Oreck Commercial" Name Plate Label	75599-02	1	1			
66	Bushing	75275-01	1	1			
76	Handle Brace	75432-01	1	1			
76a	Handle Brace Kit	75435-01	1	1			
	User's Manual	75417-05	1	1			
	Vacuum Cleaner Cover	VACCOVER	1	1	NLA	NLA	NLA
	Magnet Clean Vacuum Protector	MC4BK	1	1			
79	Stiffener (uses same length screws, notched)	75189-02	1	1			
	Stiffener, Through Bolt Connector (uses different length screws)	75619-01	1	1			
87	Front Wheel Type 7 Units Only	75709-01	2	1			

*Type 7 Units

Oreck Classic Series (Type 7 Units)-

Part Numbers Listing: U2250RS

Regular Bag, No Lights, Foot Switch

#	Item	Order #	Qty.	Pk.			
1a	Handle Assembly	75575-01	1	1			
4a	Docking Clip, Rear, Type CC (use w/#67 or order #83)	75583-03-0000	1	1			
5	Dust Bag, (8 Pk.) Regular	CCPK8	1	8			
	Dust Bag, (25 Pk.) Regular	CCPK25	1	25			
6	Outer Bag, Gray	76017-01	1	1			
8	Connector Assembly Kit, <i>includes items #3 & #84</i>	09-75308-57	1	1			
9	Collar	75199-02-0327	1	1			
10	Tube Assembly	75198-05	1	1			
11	Upper Tube with White Grip	75575-07	1	1			
12	Fan Housing Assembly <i>includes Rivet & Spring</i>	09-75343-03	1	1			
13	Switch Cover	09-75266-01	1	1			
14	Switch Assembly	75084-06	1	1			
16	End Cap	0134623	1	1			
18	METAXALLOY™ Fan Kit w/Washers	09-75300-01	1	1			
19	Fan Seal Cup	75012-01	1	1			
20	Cord Set, White	75163-03-328	1	1			
26	Top Cover w/Belt Door Assembly	09-76031-01	1	1			
27	Bumper, Clear	75765-01	1	1			
28	Intake Pivot Assembly <i>with Felt Seal</i>	09-75066-02	1	1			
29	Felt Seal	75065-01	1	1			
32	Felt Seal, Motor	75117-01M	1	100			
33	Strain Relief	03-00494-01	1	1			
34	Motor Assembly Kit	09-75505-01	1	1			
35	Motor Seal	75095-01	2	1			
36	Kit, Motor Brush (Large & Small) / Spring	09-75514-01	2	2			
39	Drive Belt, (3 Pk.)	0300604	1	3			
39a	Drive Belt, Single	75024-01	1	1			
40	Door Belt, Light Gray	76002-01-469	1	1			
42	Brush Roll, Plastic Pulley	75202-01	1	1			
43	Seal, Baseplate	75008-01	1	1			
44	Plastic Detent, (uses 2 #49 screws)	75299-01	1	1			
45	Complete Baseplate Assembly <i>includes: #43, #46, #47, #50, #51, #52, #85, #86, #87</i>	09-75715-57	1	1			
46	MICRO SWEEP Blade	75700-01	1	1			
47	Channel	75701-01	1	1			
50	Edge Brush, Silver ION	75766-03	2	1			
51	Wheel Axle	03-00630-01M	2	100			
52	Soft Rear Wheel, Black	75187-02-0327	2	1			
60	Motor Spring	75283-01	2	1			

Oreck Classic Series (Type 7 Units)-

Part Numbers Listing: U2250RS

Regular Bag, No Lights, Foot Switch

#	Item	Order #	Qty.	Pk.			
61	Tube Label	75087-05	1	1			
67	Bag Dock Hinge, Type CC (use w/#4a or order #83)	75582-03-0000	1	1			
	User's Manual	N/A	1	1			
79	Stiffener (uses same length screws, notched)	75189-02	1	1			
	Stiffener, Through Bolt Connector (uses different length screws)	75619-01	1	1			
81	Cord Flex Relief	03-00600-01	1	1			
83	Kit, Bag Dock, <i>includes items #4a & #67</i>	09-75657-01	1	1			
87	Wheel and Tire Overmolded	75709-01	2	1			

WIRING DIAGRAM

FOR ALL 120V UPRIGHTS

IMPORTANT SAFETY NOTES:

- UNPLUG UNIT BEFORE SERVICING.
- REPLACEMENT OF MOTORS SHOULD ONLY BE DONE BY AN EXPERIENCED ELECTRICIAN OR AN AUTHORIZED ORECK SERVICE CENTER.

75516-04 REV D 05/04 ECN# R-7618

<p>1</p> <p>HARDWIRE IN HANDLE RESIDENTIAL SWITCH IN HANDLE W/O LIGHTS SEE MOTOR DETAIL A & B</p>	<p>RESIDENTIAL SWITCH IN BASE W/O LIGHTS SEE MOTOR DETAIL A & B</p>	<p>D-PLUG IN HANDLE RESIDENTIAL SWITCH IN HANDLE W/O LIGHTS SEE MOTOR DETAIL A & B</p>
<p>2</p> <p>RESIDENTIAL SWITCH IN BASE W/LIGHTS 1 PARALLEL LIGHT HARNESS SEE MOTOR DETAIL C & D</p>	<p>RESIDENTIAL SWITCH IN HANDLE W/LIGHTS 1 PARALLEL LIGHT HARNESS SEE MOTOR DETAIL C & D</p>	<p>DETAIL A AMETEK MOTOR RESIDENTIAL W/O LIGHTS</p> <p>DETAIL B JOHNSON MOTOR RESIDENTIAL W/O LIGHTS</p>
<p>3</p> <p>RESIDENTIAL SWITCH IN HANDLE W/LIGHTS 1 PARALLEL LIGHT HARNESS SEE MOTOR DETAIL C & D</p>	<p>DETAIL C AMETEK MOTOR RESIDENTIAL W/LIGHTS 1 PARALLEL HARNESS</p>	<p>DETAIL D JOHNSON MOTOR RESIDENTIAL W/LIGHTS 1 PARALLEL HARNESS</p>

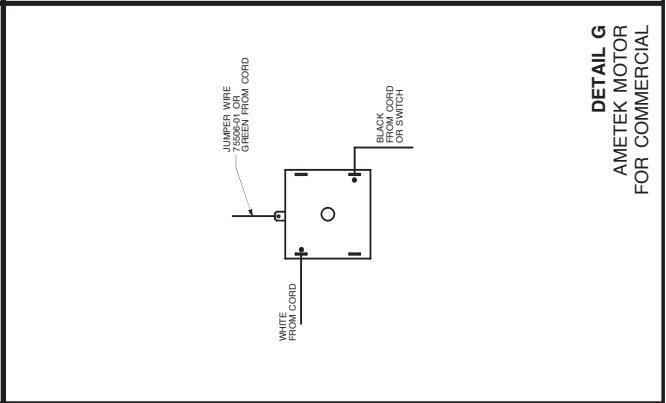
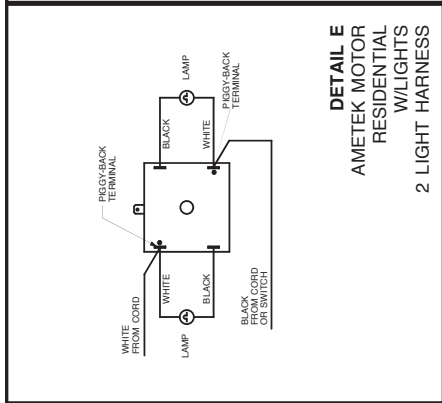
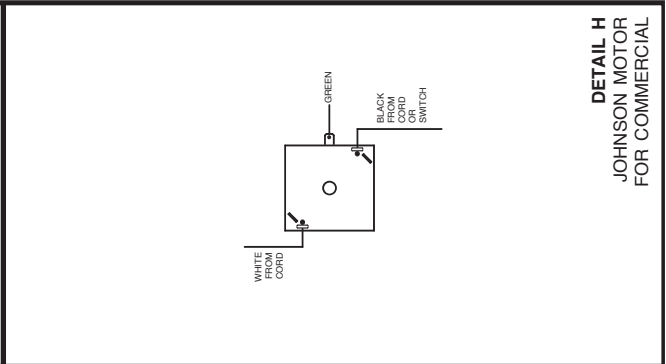
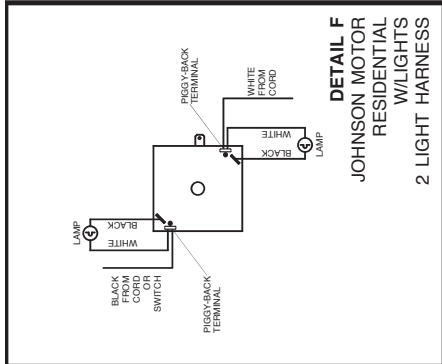
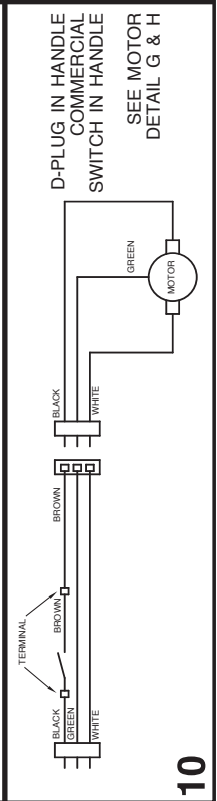
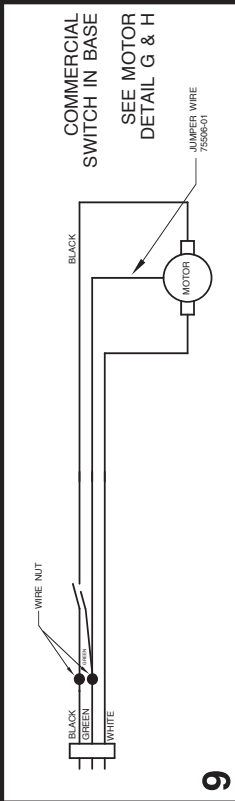
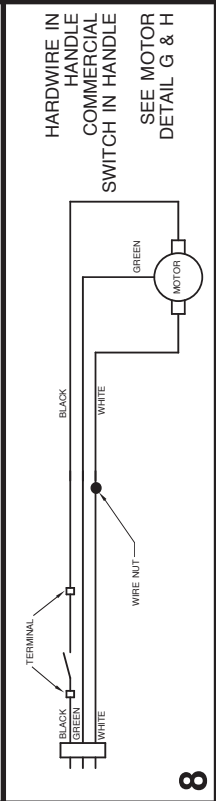
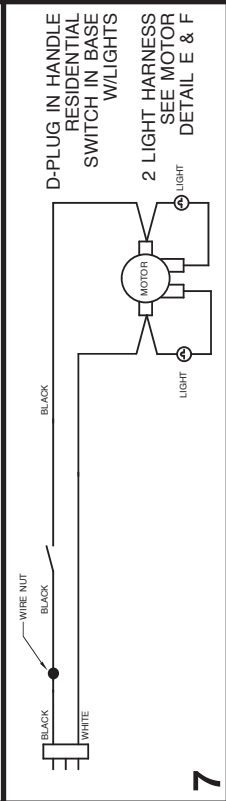
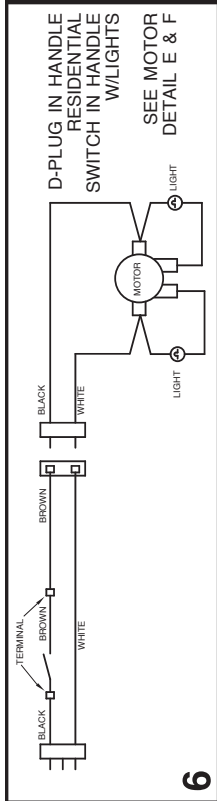

©2004 Oreck Holdings, LLC. All trademarks are owned and used under the authority of Oreck Holdings, LLC.

TOOLS

Description	Order #			
Fan Housing Removal Tool (This tool is designed to assist in removing fan housing assembly from the motor.)	75377-01			
Strain Relief Pliers (This tool is designed to remove the cord retainer, part #33.)	75383-01			
Retainer Clip Tool (This tool is designed to assist in adding retainer clips, part #77, to Baseplate.) ****Use 7/32" nutdriver.	75485-01	NLA	NLA	NLA

RETAINER CLIP REPLACEMENT

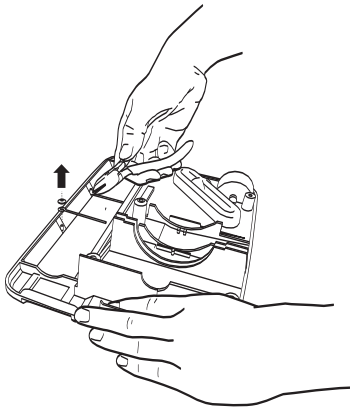

To remove the retainer clips from the baseplate, using a pair of side cutting pliers, carefully cut the retainer clips away from the posts. Remove the retainer clips. Be careful not to damage the posts.

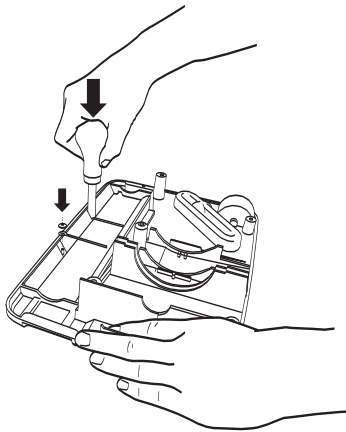

To replace the retainer clips, position the retainer clips on the posts with indentation facing downward. Use the retainer clip tool (7/32" nutdriver) to force the retainer clips down. Retainer clip should fit firmly against wireform.

ADDITIONAL REPLACEMENT PARTS

Kit Number	Description	
	<i>Note: Standard motor replacement kits</i>	
09-75505-01	Motor Kit	
75086-01	Leads, Red	
75086-02	Leads, White	NLA
75506-01	Leads, Green	
75329-01	50pc. Edge Brush Axle Kit order item #50	NLA
75338-01	20pc. Edge Brush Wheel Kit	
03-00474-01M	100pc. Edge Brush Axle Kit, Pin, .125 x .5	

Troubleshooting

Notice: Make sure the unit is unplugged before removing any part off the unit.

1. Problem Being Checked:

- | |
|-------------|
| a. Solution |
|-------------|

1. **Dust Blowing from Bottom of Unit:**

- a. Change bag ensuring it's properly installed on connector deflector.
- b. Remove lower tube and check for clog. Remove any debris.
- c. Remove baseplate and check inlet for clog. Remove any debris.
- d. Check for cracked fan housing. Replace fan housing.

2. **Unit not picking up:**

- a. Remove lower tube and check for clog.
- b. Remove baseplate and check inlet for clog.
- c. Change bag ensuring it's properly installed on connector deflector.
- d. Make sure belt is installed properly.

3. **Brush Roll Not Spinning / Belt Breaks:**

- a. Belt is older than six months and slipping or may not be installed properly. Install new belt.
- b. Bearings in brush roll worn, change brush roll.

4. **Sparking from Plug to Handle (non-hardwire units):**

- a. Make sure plug fits firmly into handle.

5. **Unit Dead:**

- a. Make sure unit is plugged into working outlet.
- b. Check switch for failure. If bad, replace switch.
- c. Check to see if motor wires are plugged and not loose.
- d. Check motor brushes and motor brush springs to make sure they have good contact.
- e. Check motor for failure. If bad, replace motor.
- f. Check cord for failure. If bad, replace cord.

6. **Parts Falling off Baseplate:**

- a. If wheels come off, replace wheels.
- b. If channel, micro sweep blade, or wireform come off, replace baseplate.

7. **Noisy Unit:**

- a. Check to see if brush roll has bad bearings. If so replace brush roll.
- b. Check to see if an object is stuck in the fan housing.
- c. Check fan in fan housing. Make sure there are no broken blades. Replace if broken.

8. **Unit Will Not Stand Up:**

- a. Broken or missing detent.

An Oreck Authorized Service Center should do all technical servicing.

